



BERNINA 535

LOOKING FOR A NEW SEWING PROJECT?

You can find what you want in "inspiration", our sewing magazine. Thanks to great sewing patterns and detailed sewing instructions, every project succeeds right away.

Inspiration magazine
is available in German, English,
French and Dutch



* Not available in all countries.

Dear BERNINA customer



Congratulations! You have decided on BERNINA and therefore on a product which will delight you for years. For more than 100 years our family company has attached greatest importance to satisfied customers. As for me, it is a matter of personal concern to offer you Swiss development and precision at the height of perfection, future-orientated sewing technology and a comprehensive customer service.

The BERNINA 5-series consists of various ultramodern machines, whose development not only focused the highest demands on technique and the ease of use but also considered the design of the product. After all we sell our products to creative people like you, who do not only appreciate high quality but also form and design.

Enjoy the creative sewing, embroidering and quilting on your new BERNINA 535 and keep informed about the various accessories at www.bernina.com. On our homepage you will also find a lot of inspiring sewing instructions, to be downloaded for free.

Our highly trained BERNINA dealers will provide you with more information on service and maintenance offers.

I wish you lots of pleasure and many creative hours with your new BERNINA.

H.P. Ueltschi

Owner

BERNINA International AG

CH-8266 Steckborn



Edition notice

Graphics

www.sculpt.ch

Text, Setting and Layout

BERNINA International AG

Fotos

Patrice Heilmann, Winterthur

Part number

2017/10 en 1028875.0.04

1st Edition

Copyright

2017 BERNINA International AG

All rights reserved: For technical reasons and for the purpose of product improvements, changes concerning the features of the machine can be made at any time and without advance notice. The supplied accessory can vary depending on the country of delivery.

Contents

IMPORTANT SAFETY INSTRUCTIONS	14
1 My BERNINA	18
1.1 Introduction	18
1.2 Welcome to the world of BERNINA	18
1.3 Key to signs	19
1.4 Overview Machine	20
Overview front controls	20
Overview front	21
Overview sideways	22
Overview back	23
1.5 Supplied accessories.....	23
Overview accessories machine	23
Use of the power cable (only USA/Canada).....	25
Overview presser feet	26
Accessory box.....	27
1.6 Overview User Interface	28
Overview functions/visual information	28
Overview System settings	28
Overview selection menu sewing	29
Overview Icons	29
1.7 Needle, Thread, Fabric.....	30
Overview needles	30
Example for needle description	32
Thread selection	32
Needle/thread combination	33
2 Sewing preparation	34
2.1 Accessory box	34
Removing and attaching the accessory box.....	34
Storing accessories	34
2.2 Connection and Switching on	35
Connecting the foot control	35
Connecting the machine	35
Attaching the knee lifter of the Free Hand System	35
Fixing the touchscreen pen	36
Switching the machine on	36
2.3 Foot control	36
Regulating the speed via the foot control	36
Raising/Lowering the needle	37
2.4 Spool pin	37
Retractable spool pin	37
Horizontal spool pin	38
2.5 Free arm	39
2.6 Feed dog.....	39
Adjusting the feed dog.....	39

2.7	Slide-on table.....	40
	Using the slide-on table	40
2.8	Presser foot.....	41
	Adjusting the presser position via the knee lifter of the Free Hand System	41
	Changing the presser foot.....	41
	Having the presser foot displayed in the user interface.....	42
	Adjusting the presser foot pressure.....	42
2.9	Adjusting the feed dog	43
2.10	Needle and stitch plate.....	43
	Changing the needle	43
	Selecting the needle in the User Interface	43
	Select the needle type and the needle size.....	43
	Adjusting the needle position up/down	44
	Adjusting the needle position left/right.....	44
	Needle stop up/down (permanent)	44
	Changing the stitch plate	45
	Selecting the stitch plate in the User Interface.....	45
2.11	Threading	46
	Threading the upper thread.....	46
	Threading the double needle	48
	Threading the triple needle.....	49
	Winding the bobbin thread	50
	Threading the bobbin thread	50
	Instruction how to thread the bobbin thread	53
3	Setup Program	54
3.1	Sewing settings.....	54
	Adjusting the upper thread tension	54
	Adjusting the maximum sewing speed.....	54
	Programming securing stitches	54
	Programming the button «Thread cutter»	55
	Programming the button «Securing»	55
	Programming the button «Quick reverse»	56
3.2	Embroidery settings.....	56
	Adjusting the upper thread tension	56
	Adjusting the maximum embroidering speed.....	57
	Centering the embroidery motif or opening in original position	57
	Calibrating the hoop	58
	Entering the fabric thickness.....	58
	Programming securing stitches (Smart Secure).....	59
	Adjusting the thread cut.....	59
	Changing the measuring unit	60
3.3	Selecting personal settings	61
3.4	Monitoring functions	62
	Activating the upper thread indicator	62
3.5	Activating the audio signals.....	62
3.6	Machine settings.....	63
	Selecting a language	63
	Adjusting the brightness of the display	63



	Adjusting the sewing light	63
	Checking the firmware version	64
	Reviewing the total number of stitches	64
	Registering details of the dealer	65
	Saving Service data	65
	Back to basic setting	66
	Deleting user data	66
	Deleting motifs on the BERNINA USB Stick	67
	Calibrating the Buttonhole foot No. 3A	67
	Updating the machine Firmware	68
	Recovering saved data	69
	Cleaning the thread catcher	69
	Lubricating the machine	70
	Packing the embroidery module	70
4	System settings.....	72
4.1	Calling up the Tutorial	72
4.2	Calling up the Creative Consultant	72
4.3	Using eco mode	72
4.4	Calling up the Help	72
4.5	Cancelling any alterations with «clr»	73
5	Creative sewing	74
5.1	Overview selection menu sewing	74
	Selecting a stitch pattern	74
5.2	Regulating the speed	74
5.3	Adjusting the upper thread tension	74
5.4	Editing stitch patterns	75
	Changing the stitch width	75
	Changing the stitch length	75
	Correcting the balance	76
	Programming pattern repeat	76
	Mirror image of stitch patterns	76
	Quick reverse.....	77
	Permanent Quick reverse	77
	Backstepping.....	77
5.5	Combining stitch patterns	78
	Overview Combi mode	78
	Creating Stitch pattern combinations.....	78
	Saving a stitch pattern combination.....	78
	Loading a stitch pattern combination.....	78
	Overwriting a stitch pattern combination	79
	Deleting a stitch pattern combination	79
	Editing a single stitch pattern.....	79
	Deleting a single stitch pattern	79
	Adding a single stitch pattern	80
	Mirroring a stitch pattern combination	81
	Stitch pattern combination Subdivider 1	81
	Stitch pattern combination Subdivider 2	81

	Securing a stitch pattern combination.....	81
	Programming pattern repeat	82
5.6	Administering stitch patterns.....	82
	Saving settings of stitch patterns	82
	Saving stitch patterns in personal memory	82
	Overwriting stitch patterns from the personal memory	83
	Loading stitch patterns from the personal memory	83
	Deleting stitch patterns from the personal memory.....	83
	Uploading a stitch pattern from the BERNINA USB stick	83
	Deleting stitch patterns from the BERNINA USB stick	84
5.7	Securing.....	84
	Securing a seam with the button «Securing»	84
	Securing via the icon «Securing»	84
5.8	Height Compensation of uneven layers	85
5.9	Sewing Corners.....	86
6	Practical stitches	87
6.1	Overview Practical stitches.....	87
6.2	Sewing straight stitch.....	89
6.3	Securing with the automatic Securing Program	90
6.4	Sewing in the zipper	90
6.5	Sewing both sides of the zipper from bottom to top	91
6.6	Sewing triple straight stitch	92
6.7	Sewing Triple zig zag	93
6.8	Manual darning	93
6.9	Automatic darning.....	95
6.10	Reinforced darning, automatic	96
6.11	Reinforced Darning Program	97
6.12	Finishing edges	97
6.13	Sewing Double overlock.....	98
6.14	Narrow edgestitching.....	98
6.15	Wide edgestitching	98
6.16	Edgestitching using the seam guide (optional accessory)	99
6.17	Sewing hem edges.....	99
6.18	Sewing blind hems.....	100
6.19	Sewing visible hems	101
6.20	Sewing flat joining seams.....	102
6.21	Sewing basting stitches	102
7	Decorative stitches	103
7.1	Overview Decorative Stitches.....	103
7.2	Bobbin-Play.....	104
7.3	Sewing cross stitches.....	105



7.4	Pintucks	105
	Pintucks.....	105
	Overview pintucks	106
	Inserting the cord	106
	Sewing Pintucks	107
8	Alphabets	108
8.1	Overview Alphabet.....	108
8.2	Creating lettering.....	108
9	Buttonholes.....	110
9.1	Overview Buttonholes	110
9.2	Making use of the height compensation tool	111
9.3	Using the compensation plate	112
9.4	Marking buttonholes.....	112
9.5	Cord	113
	Using cord with the Buttonhole foot with slide No. 3A	113
	Using cord with the Buttonhole foot with slide No. 3 (optional accessory).....	114
9.6	Sewing a test sample	115
9.7	Determining the buttonhole slit width.....	115
9.8	Determining the buttonhole length	116
9.9	Using the stitch counter function	116
9.10	Sewing a buttonhole automatically	117
9.11	Programming the Heirloom buttonhole	118
9.12	Sewing the manual 7-step buttonhole.....	118
9.13	Sewing the manual 5-step buttonhole.....	119
9.14	Cutting the buttonhole open with the seam ripper.....	120
9.15	Cutting open buttonholes with the buttonhole cutter (optional accessory)	120
9.16	Sewing on buttons.....	120
9.17	Sewing eyelets	121
10	Quilting	122
10.1	Overview Quilt Stitches	122
10.2	Quilting, Securing Program	123
10.3	Sewing handlook quilt stitches	123
10.4	Guiding the quilt work freely.....	124
11	BERNINA Stitch Regulator (BSR)	125
11.1	BSR mode 1	125
11.2	BSR mode 2	125
11.3	BSR function with Straight stitch No. 1	125
11.4	BSR function with Zig zag No. 2	125
11.5	Sewing preparations for quilting	125
	Attach the BSR presser foot	125

	Changing the presser foot sole	126
11.6	Using the BSR mode.....	126
11.7	Securing.....	127
	Securing in BSR1 mode with the button «Start/Stop»	127
	Securing in BSR2 mode.....	127
12	My BERNINA Embroidery	129
12.1	Overview Embroidery module.....	129
12.2	Supplied accessories Embroidery module.....	129
	Overview Accessories Embroidery module.....	129
12.3	Overview User Interface	130
	Overview functions/visual information	130
	Overview System settings	131
	Overview Selection menu embroidery	131
12.4	Important Embroidery information	131
	Upper thread.....	131
	Bobbin thread	132
	Selecting the embroidery file format	132
	Embroidery test	133
	The size of the embroidery motif	133
	Embroidering motifs by third-party providers	133
	Underlay stitches	133
	Satin stitch	133
	Step stitch	134
	Connecting stitches.....	134
13	Embroidering preparation	135
13.1	Attaching the Module.....	135
13.2	Removing the embroidery module.....	135
13.3	Preparing the machine	136
	Lowering the feed dog	136
	Selecting an embroidery motif	136
13.4	Embroidery foot.....	136
	Attaching the embroidery foot	136
	Selecting the presser foot in the User Interface	137
13.5	Needle and stitch plate.....	138
	Inserting the embroidery needle	138
	Selecting the embroidery needle in the User Interface.....	138
	Selecting the needle type and the needle size	138
	Attaching the stitch plate	139
	Selecting the stitch plate in the User Interface.....	140
	Thread-up command	140
13.6	Embroidery hoop	140
	Overview Embroidery hoop selection	140
	Selecting the embroidery hoop.....	140
	Tear-away stabilizers.....	141
	Cut-away stabilizers.....	141
	Using adhesive spray	141
	Using spray starch	141



Using iron-on interfacing	141
Using paper-backed adhesive stabilizer	141
Using water-soluble stabilizer	142
Preparing the embroidery hoop	142
Attaching the hoop	143
Overview Embroidery functions	144
Center the needle to the embroidery hoop	144
Moving the hoop to the back	144
Moving the module for the sewing mode	144
Grid on/off	145
Locating the center of the embroidery motif	145
Virtual positioning of the embroidery hoop	145
14 Setup Program	146
14.1 Adjusting the embroidery settings in the Setup Program	146
15 Creative embroidering	147
15.1 Overview embroidering	147
15.2 Selecting and changing the embroidery motif	147
15.3 Checking the embroidery time and the embroidery motif size	147
15.4 Regulating the speed	147
15.5 Editing the embroidery motif	148
Overview Editing embroidery motif	148
Scaling up the embroidery motif view	148
Downsizing the embroidery motif view	148
Moving the embroidery motif view	148
Moving the embroidery motif in enlarged view	149
Moving the embroidery motif	149
Rotating motif	149
Altering the embroidery motif size proportionally	150
Altering the embroidery motif size disproportionately	150
Mirroring embroidery motifs	151
Bending the text	151
Changing the stitch type	151
Altering the stitch density	152
Checking the size and the position of the embroidery motif	152
Duplicating the embroidery motif	153
Deleting an embroidery motif	153
15.6 Combining embroidery motifs	153
Combining embroidery motifs	153
Deleting a single embroidery motif	154
Duplicating the embroidery motif	154
Duplicating a combination	154
15.7 Creating lettering	155
Overview embroidery alphabets	155
Creating words/sentences	156
Editing words/sentences	156
15.8 Changing the colors of the embroidery motif	157
Overview changing the color	157
Changing the colors	158

	Changing the thread brand	158
15.9	Embroidering the embroidery motif.....	159
	Overview Embroidery menu.....	159
	Adding basting stitches	159
	Moving the hoop.....	159
	Embroidery sequence control when thread breaks	159
	Cutting connecting stitches	160
	Reducing color changes.....	160
	Multi-colored embroidery motif on/off.....	160
	Color indication.....	160
15.10	Free arm embroidering.....	161
15.11	Administering embroidery motifs	162
	Administering embroidery motifs.....	162
	Saving embroidery motifs in the personal memory.....	162
	Saving the embroidery motif on the BERNINA USB stick.....	162
	Overwriting the embroidery motif in the personal memory	162
	Overwriting the embroidery motif on the BERNINA USB stick.....	163
	Importing stitch patterns	163
	Loading an embroidery motif from the personal memory.....	163
	Loading an embroidery motif from the BERNINA USB stick	164
	Deleting an embroidery motif from the personal memory	164
	Deleting an embroidery motif from the BERNINA USB stick.....	164
16	Embroidery.....	165
16.1	Embroidering via the button «Start/Stop»	165
16.2	Increasing the embroidery speed	165
16.3	Adjusting the upper thread tension	165
16.4	Embroidering via the foot control.....	166
17	Attachment	167
17.1	Maintenance and cleaning	167
	Cleaning the display	167
	Cleaning the feed dog.....	167
	Cleaning the hook.....	167
	Lubricating the hook	168
17.2	Troubleshooting.....	170
17.3	Error messages.....	173
17.4	Storage and disposal.....	177
	Storing the machine	177
	Dispose of the machine	177
17.5	Technical data.....	178
18	Overview motifs.....	179
18.1	Overview Stitch patterns	179
	Practical stitches	179
	Buttonholes.....	179
	Decorative stitches.....	179
18.2	Overview Embroidery motifs.....	183



Editing embroidery motifs..... 183
Quilt motifs 183
Ornaments 184
Flowers..... 184
Children 185
Seasons 185
Sports and hobby 186
Animals 187
Borders and Lace 188
Frames and borders 188
Designs with special effects 189
Index..... 190

IMPORTANT SAFETY INSTRUCTIONS

Please be aware of the following basic safety instructions when using your machine. Before using this machine, read instruction manual carefully.

DANGER!

To reduce the risk of electrical shock:

- Never leave the machine unattended as long as it is plugged in.
- Always unplug the machine from the electrical outlet immediately after using and before cleaning.

Protection against LED radiation:

- Do not view the LED light directly with optical instruments (e.g. magnifier). The LED light corresponds with protection class 1M.

Protection against injuries:

- Attention moving parts. To avoid injuries, switch off the machine before manipulations are carried out. Always close the cover when operating the machine.



WARNING

To reduce the risk of burns, fire, electric shock or injury to persons:

- To operate the machine always use the supplied power cable. The power cable for USA and Canada (power plug NEMA 1-15) must only be used for a power supply of maximal 150V against ground.
- Use this machine only for purposes as described in this manual.
- Do not use the machine outdoors.
- Do not use this machine as a toy. Close attention is necessary when this machine is used by or near children.
- The machine can be used by children older than 8 or by people with reduced physical, sensory or mental capabilities or if there is a lack of experience and knowledge how to operate the machine as long as they are supervised or have been given instruction concerning the responsible use of the appliance and are aware of the involved risks.
- Children are not allowed to play with this machine.
- Cleaning and maintenance work must not be carried out by children unless they are supervised.
- Never operate this machine if it has a damaged cord or plug, if it is not working properly, if it has been dropped or damaged, or dropped into water. Contact the nearest authorized BERNINA dealer to arrange further details.
- Only use accessories recommended by the manufacturer.
- Don't use this machine when the ventilation openings are blocked. Keep the ventilation openings free from the accumulation of lint, dust and loose cloth.
- Never insert any objects into any openings of the machine.

- Do not operate the machine where aerosol products (sprays) or oxygen are being used.
- Keep fingers away from all moving parts. Special care is required around the needle.
- Neither pull nor push the fabric while sewing. This can cause needle breakage.
- When making any adjustments in the needle area - such as threading the needle, changing the needle, threading the hook or changing the presser foot - turn the power switch to «0».
- Do not use bent needles.
- Always use the original BERNINA stitch plate. The wrong stitch plate can cause needle breakage.
- To disconnect, turn power switch to «0» and then remove the plug from the outlet. Do not unplug by pulling the cord, instead grasp the plug to pull it from the outlet.
- Always disconnect the power plug from the electrical outlet when the covers are removed or opened, when the machine is lubricated or during any other maintenance adjustments mentioned in the instruction manual.
- This machine is provided with double insulation. Use only identical replacement parts. See instructions for Servicing of double-insulated products.



Servicing of double-insulated products

In a double-insulated product two systems of insulation are provided instead of grounding. No grounding means is provided on a doubleinsulated product, nor should a means for grounding be added to the product. Servicing a double-insulated product requires extreme care and knowledge of the system and should be done only by qualified service personnel. Replacement parts for a double-insulated product must be identical to the original parts in the product. A double-insulated product is marked with the words: «Double insulation» or «double-insulated».

The symbol may also be marked on the product.

KEEP THE INSTRUCTION MANUAL SAFE

Appropriate use

Your BERNINA machine is conceived and designed for private household use. It answers the purpose to quilt fabrics as it is described in this instruction manual. Any other use is not considered appropriate. BERNINA assumes no liability concerning consequences resulting from an inappropriate usage.

1 My BERNINA

1.1 Introduction

With your BERNINA 535 you can sew, embroider and quilt. Delicate silk or satin fabrics as well as heavy-weight linen, fleece and denim can be sewn without any problems with this machine. Numerous practical as well as decorative stitches, buttonholes and embroidery motifs are at your disposal.

Additional to this instruction manual, subsequently listed help programs are provided which will give you useful advice and support at any time how to operate your BERNINA 535.

The **Tutorial** gives information and explanations, covering various aspects of sewing, embroidering and the different stitches.

The **Creative Consultant** informs you about decision support for sewing projects. After entering the kind of fabric and the desired sewing project, suggestions concerning the suitable needle or the appropriate presser foot are displayed.

The **Help Program** contains information about individual stitch patterns, functions and applications in the display.

Further information

In addition to this instruction manual of your BERNINA 535 further information products are enclosed.

The latest version of your instruction manual as well as additional information in connection with the machine and accessories can be found on our website <http://www.bernina.com>

1.2 Welcome to the world of BERNINA

Made to create, this is the slogan of BERNINA. Not only our machines do support you to implement your ideas, but on top of that, our below mentioned opportunities also offer various inspirations and instructions for your future projects as well as the option to exchange ideas with other sewing and embroidering enthusiasts. We wish you lots of pleasure doing that.

BERNINA YouTube Channel

On YouTube we offer a wide range of how-to videos and support concerning the most important functions of our machines. Detailed explanations are also provided as for the various presser feet, so that your projects will succeed completely.

<http://www.youtube.com/BerninaInternational>

Provided in the languages English and German.

inspiration – the sewing magazine

Are you looking for ideas, sewing patterns and instructions for great projects? In that case the BERNINA magazine «inspiration» is exactly what you need. «inspiration» offers extraordinary sewing and embroidery ideas four times a year. From seasonal fashion trends to trendy accessories and practical tips to decorate your home in an original way.

<http://www.bernina.com/inspiration>

The magazine is available in the languages English, German, Dutch and French. Not available in all countries.

BERNINA Blog

Fancy instructions, free sewing patterns and embroidery motifs as well as many new ideas: all this you can find in the weekly blog by BERNINA. Our experts give valuable tips and explain step by step how you can achieve the desired result. In the community you can upload your own projects and exchange experiences and ideas with other sewing and embroidering enthusiasts.

<http://www.bernina.com/blog>

Provided in the languages English, German and Dutch.

BERNINA Social Media

Follow us on the social networking to learn more about events, thrilling projects as well as tips and tricks all about sewing and embroidering. We will keep you informed and we are looking forward to presenting you the one or the other highlight from the world of BERNINA.

<http://www.bernina.com/social-media>

1.3 Key to signs



Labels a danger with a high risk which can lead to death or severe injury unless it is avoided.



Labels a danger with a medium risk which can lead to death or severe injury unless it is avoided.



Labels a danger with a low risk which can lead to light or medium injury unless it is avoided.

NOTICE

Labels a danger which can end up with damage unless it is avoided.



Tips given by BERNINA **sewing experts** can be found next to this sign.

By means of illustration, sample pictures are used in this instruction manual. The machines as well as the accessory shown in the pictures may vary from the delivery content of your machine.

1.4 Overview Machine

Overview front controls



- 1 Quick reverse
- 2 Thread cutter
- 3 Securing
- 4 Start/Stop
- 5 Pattern end

- 6 Needle up/down
- 7 Presser foot pressure
- 8 Upper Multifunctional knob
- 9 Lower Multifunctional knob
- 10 Needle left/right

Overview front



- | | | | |
|---|---|----|---------------------------------|
| 1 | Connection for embroidery module | 9 | Thread take-up lever cover |
| 2 | Bobbin cover | 10 | Presser foot pressure |
| 3 | Connection for accessory (optional accessory) | 11 | Thread take-up lever |
| 4 | Presser foot | 12 | Thread cutter |
| 5 | Needle threader | 13 | Fixing screw |
| 6 | Sewing light | 14 | Connection for slide-on table |
| 7 | Thread cutter | 15 | Connection for Free Hand System |
| 8 | Slide speed control | | |

Overview sideways



- 1 Connection for foot control
- 2 Feed dog up/down
- 3 PC-connection
- 4 USB port
- 5 Spool pin
- 6 Bobbin winding unit

- 7 Retractable spool pin
- 8 Air vents
- 9 Handwheel
- 10 Power switch
- 11 Connection for power cable
- 12 Magnet holder for touchscreen pen

Overview back



- | | | | |
|---|-------------------------------|----|----------------------|
| 1 | Air vents | 9 | Bobbin winding unit |
| 2 | Connection for slide-on table | 10 | Thread pretension |
| 3 | Connection for darning hoop | 11 | Thread take-up lever |
| 4 | Presser foot lifter | 12 | Thread guide |
| 5 | Carrying handle | 13 | Thread cutter |
| 6 | Spool pin | 14 | BSR connection |
| 7 | Thread guide | 15 | Feed dog |
| 8 | Retractable spool pin | 16 | Stitch plate |

1.5 Supplied accessories

Overview accessories machine

All rights reserved: For technical reasons and for the purpose of product improvements, changes concerning the features of the machine can be made at any time and without advance notice. The supplied accessory can vary depending on the country of delivery.

Visit www.bernina.com for more accessory information.

























Illustration	Name	Purpose
	Soft Cover with pocket	The soft cover protects the machine from dust and contamination.
	Accessory box	The accessory box serves the purpose to store the supplied accessories as well as the optional accessories.
	Knee lifter	The presser foot may be raised and lowered with the Free Hand System.
	Slide-on table	The slide-on table increases the sewing surface whereby the area of the free arm is not limited.
	3 Spool discs	Spool discs hold the thread spool in place for proper release of thread from the spool.
	4 Bobbins in the accessory, whereby 1 bobbin is already in the bobbin case.	The bobbins are filled with the lower thread.
	2 Foam pads	The foam pad prevents the thread from getting hooked at the spool pin.
	Touchscreen pen	The operation of the display is more precise when using the touchscreen pen instead of the fingers.
	Seam ripper	The seam ripper is an indispensable tool to undo stitches or to cut buttonholes open.
	Height compensation tool	The height compensation tool levels an angled position of the presser foot sole when sliding over thick seams.

Illustration	Name	Purpose
	Selection of needles	The needle assortment contains different versions and sizes of needles for all the common applications.
	Screwdriver red	The red screwdriver is supplied as an all-round tool.
	Brush	The brush is used to clean the feed dog and the hook area.
	Lubricator	The lubricator is used to fill up the oil depots.
	Power cable	The power cable connects the machine with the power supply system.
	Foot control	Via the foot control the machine is started and stopped. The speed of the machine is also controlled via the foot control. Always use the foot control of the type LV1 with this machine.

Use of the power cable (only USA/Canada)

The machine has a polarized plug (one blade wider than the other). To reduce the risk of electrical shock, this plug is intended to fit in a polarized outlet only one way. If the plug does not fit fully in the outlet, reverse the plug. If it still does not fit, contact a qualified electrician to install the proper outlet. Do not modify the plug in any way!

Overview presser feet

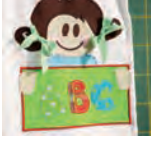
Illustration	Number	Name	Purpose	Example
	1	Reverse pattern foot	With the Reverse pattern foot, you will succeed sewing various practical and decorative stitches as well as sewing hems on heavy-weight fabrics such as cord, jeans or wool. The notch both in front and behind the stitch hole allows sewing stitches in forward and backward direction and ensures an excellent fabric feed.	
	2	Overlock foot	The Overlock foot suits perfectly to sew overlock seams and finishing edges in elastic material. The fabric edges don't curl and the result is a flat elastic seam.	
	3A	Automatic Buttonhole foot with slide	This foot is used to sew buttonholes with or without cord. The sensor can measure the buttonholes automatically on the base of the size of the desired button. Therefore any number of buttonholes can be sewn exactly at the same length. In combination with the compensation plate or the height compensating tool as well as the buttonhole cutter and the Button sew-on foot, perfect buttonholes can be worked out in a simple way.	
	4	Zipper foot	With the Zipper foot you will manage to sew in zippers in no time - properly and exactly. The narrow sole is positioned close to the zipper coils to sew in the zipper tightly fitting along the edge.	
	20	Open embroidery foot	Appliqués, decorative patterns.	

Accessory box

All rights reserved: For technical reasons and for the purpose of product improvements, changes concerning the features of the machine can be made at any time and without advance notice. The supplied accessory can vary depending on the country of delivery.

The illustrated accessories (kind and number) serve as examples and may not match with the supplied accessories.



- | | | | |
|---|--------------|---|---|
| 1 | Drawer | 5 | Foam pad |
| 2 | Presser feet | 6 | Automatic Buttonhole foot with slide |
| 3 | Spool holder | 7 | Selection of needles |
| 4 | Spool discs | 8 | Presser foot holders for 5.5 mm and 9.0 mm feet |

1.6 Overview User Interface

Overview functions/visual information

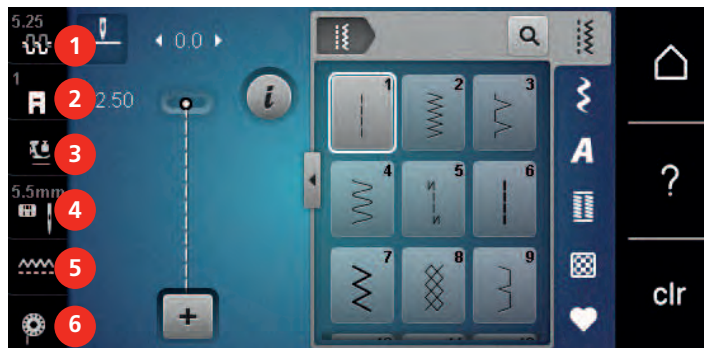

- | | | | |
|---|------------------------|---|---|
| 1 | Upper thread tension | 4 | Stitch plate/Needle selection |
| 2 | Presser foot indicator | 5 | Feed dog up/down |
| 3 | Presser foot pressure | 6 | Instruction how to thread the bobbin thread |

Overview System settings

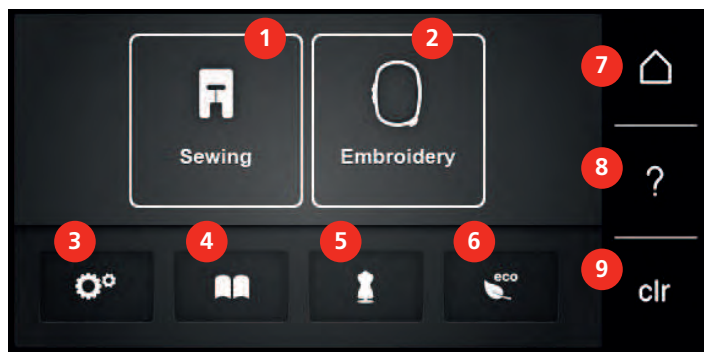

- | | | | |
|---|---------------------|---|-------------------------|
| 1 | Sewing mode | 6 | eco mode |
| 2 | Embroidery mode | 7 | Home |
| 3 | Setup Program | 8 | Help |
| 4 | Tutorial | 9 | Back to default setting |
| 5 | Creative Consultant | | |

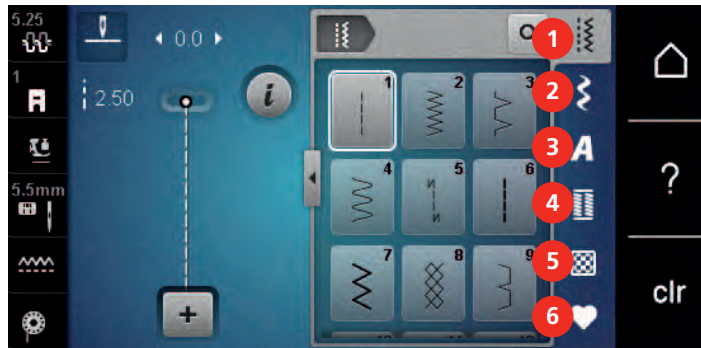

Overview selection menu sewing



- | | | | |
|---|---------------------|---|-----------------|
| 1 | Practical stitches | 4 | Buttonholes |
| 2 | Decorative stitches | 5 | Quilt stitches |
| 3 | Alphabets | 6 | Personal Memory |

Overview Icons

Icon	Name	Purpose
	i-Dialog	Touching the icon «i»-Dialog provides various functions to edit motifs.
	Close	The display is closed and the previously made adjustments are saved.
	Icons «-/+»	By touching the icons «-» and «+» the setting values are changed.
	Yellow frame around the icon	A yellow-framed icon indicates that a setting or a value in this function has been changed. By touching the yellow-framed icon, the default setting can be restored.
	Confirm	Confirms the previously adjusted alterations. The display is closed.
	Cancel	The process is canceled. The display is closed and the previously made adjustments are not saved.
	Slide	By moving the slide the setting values are changed.

Icon	Name	Purpose
	Switch	Activates or deactivates functions.
	Process navigation	With the process navigation scrolling back in the display is possible.
	Swipe function	By swiping the display using the touchscreen pen or the finger upwards or downwards, further functions can be displayed.

1.7 Needle, Thread, Fabric

In the course of time a needle wears out. Therefore it should be replaced regularly. Only a perfect point results in a good stitching result. In general it can be said: the thinner the thread, the finer the needle. The illustrated needles are either standard or optional accessory, depending on the machine.

- Needle sizes 70, 75: for thin fabrics.
- Needle sizes 80, 90: for medium fabrics.
- Needle sizes 100, 110 and 120: for heavy fabrics.

Overview needles

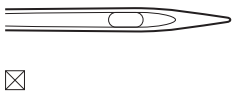
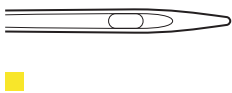
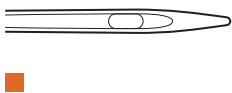
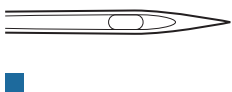
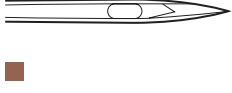

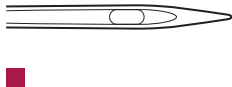
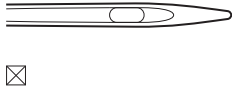
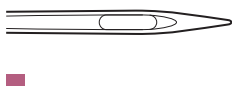
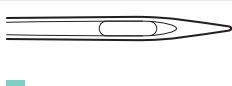

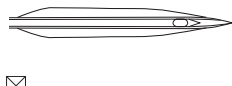
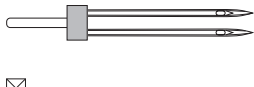
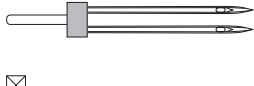

Illustration	Needle name	Needle description	Purpose
	Universal needle 130/705 H 60-120	Slightly rounded point	For nearly all natural and synthetic fabrics (woven and knitted).
	Stretch needle 130/705 H-S 75, 90	Medium ball point, special eye shape and channeling	Jersey, tricot, knit and stretch fabrics.
	Jersey/Embroidery needle 130/705 H SUK 60-100	Medium ball point	Knitware, embroidery.
	Jeans needle 130/705 H-J 80-110	Sharp fine point, reinforced shank	Heavy-weight fabrics such as jeans, canvas.
	Leather needle 130/705 H LR 90, 100	With cutting point (LR = special point to sew leather)	All types of leather, synthetic leather, plastic, sheeting.
	Microtex needle 130/705 H-M 60-110	Especially fine point	Micro fiber fabrics and silk.
	Quilting needle 130/705 H-Q 75, 90	Slightly rounded fine point	Straight and topstitching.

Illustration	Needle name	Needle description	Purpose
	Embroidery needle 130/705 H-E 75, 90	Small ball point, especially large needle eye and wide thread groove	Embroidery on all natural and synthetic fabrics.
	Fine material needle 130/705 H SES 70, 90	Fine ball point	Fine knitware, embroidering fine, delicate fabrics.
	Metafil needle 130/705 H METAFIL 80	Long needle eye (2 mm) in all needle sizes	Sewing projects with metallic threads.
	Cordonnet needle (to patch embroidery) 130/705 H-N 70-100	Long needle eye (2 mm) in all needle sizes	Topstitching with thick thread.
	Felt needle PUNCH	Needle with barbed hook	Felt work.
	Hemstitch needle 130/705 H WING 100-120	Wing-like widened needle shaft (wing)	Hemstitching.
	Universal double needle 130/705 H ZWI 70-100	Needle distance: 1.0/1.6/2.0/2.5/ 3.0/4.0/6.0/8.0	Visible hems in stretch fabrics: pintucks, decorative sewing.
	Stretch double needle 130/705 H-S ZWI 75	Needle distance: 2.5/4.0	Visible hems in stretch fabrics: pintucks, decorative sewing.
	Hemstitch double needle 130/705 H ZWIHO 100	Needle distance: 2.5	For special effects with hemstitch embroidery.
	Universal triple needle 130/705 H DRI 80	Needle distance: 3.0	Visible hems in stretch fabrics, pintucks, decorative sewing.

Example for needle description

The 130/705 system, which is the most common for household machines, is explained by the following picture of a Jersey/Stretch needle.



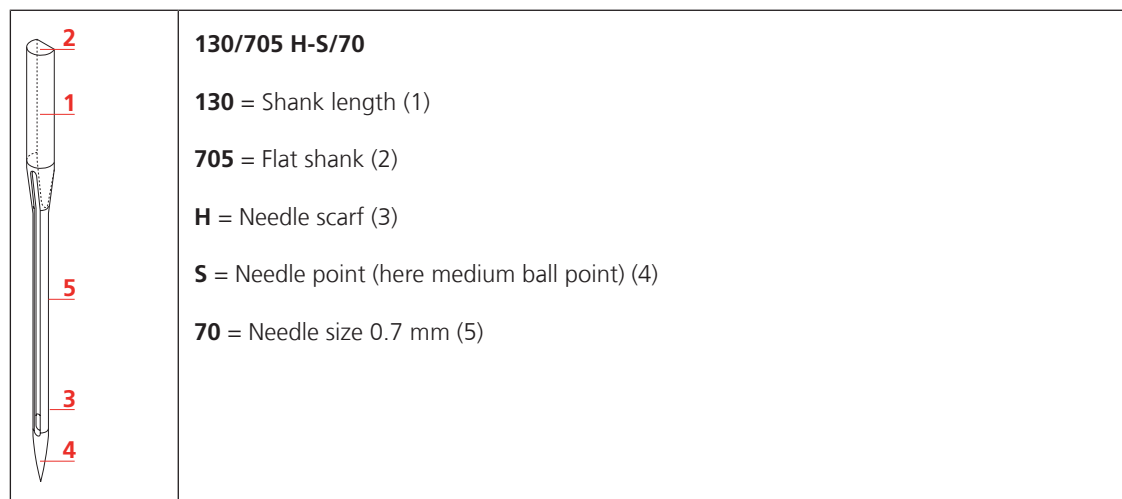

Thread selection

For a perfect sewing result, thread and fabric quality play an important role.

We recommend purchasing quality threads to achieve good sewing results.

- Cotton threads have the advantage of being a natural fiber and therefore are especially suitable for sewing cotton fabrics.
- Mercerized cotton threads have a slight sheen that is not lost with washing.
- Polyester threads have a high tensile strength and is particularly colorfast.
- Polyester threads are more flexible and are recommended where a strong and elastic seam is required.
- Rayon threads are made of natural fibers and have a brilliant sheen.
- Rayon threads are suitable for decorative stitches and achieve a more beautiful effect.

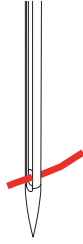
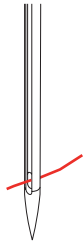
Needle/thread combination

	<p>The needle/thread combination is correct, when the thread fits perfectly into the long groove and goes easily through the needle eye. The thread can be optimally sewn.</p>
	<p>The thread can break and skipped stitches can occur when there is too much clearance in the long groove and the needle eye.</p>
	<p>The thread can break and get stuck when the thread scrapes against the edge of the long groove not fit well into the needle eye optimally.</p>

2 Sewing preparation

2.1 Accessory box

Removing and attaching the accessory box

The accessory box is fixed to the machine by means of four magnets. When attaching, the drawer has to be integrated in the accessory box.

- > Turn the carrying handle up and hold it in place.
- > Tilt the accessory box slightly to the front and pull off.



- > Close the doors of the accessory box.
- > Attach the accessory box to the machine, having the back towards the machine.

Storing accessories

NOTICE

Incorrect sorting of the bobbin

The silvery sensor surface can get scratched.

- > Make sure that the silvery sensor surfaces are on the right side when sorting the bobbins into the accessory box.
-
- > Insert the holders (1) for bobbins, feet and needles.
 - > Store the small parts, e.g. lubricator etc., in the drawer (2).
 - > Insert the bobbins into the compartment (3) of the accessory box so that the silvery sensor surfaces are on the right side.
 - > To remove a bobbin, press the compartment holder down.
 - > Place the small and the medium thread disc on the pin (4).
 - > Store the foam pads in the compartment (5).
 - > Store the Buttonhole foot with slide No. 3A in compartment (6).
 - > Store the provided needle package in the special compartment (7).
 - > Store the presser feet in the holders (1) (5.5 mm or 9.0 mm).



2.2 Connection and Switching on

Connecting the foot control

- > Unwind the cable of the foot control to the desired length.



- > Insert the cable of the foot control into the foot control connection.



Connecting the machine

- > Insert the power cable into the power cord connection.



- > Insert the plug of the power cable into the electrical outlet.

Attaching the knee lifter of the Free Hand System



The lateral position of the knee lifter can be adjusted by your local BERNINA Dealer required.

- > Insert the knee lifter into the opening at the front side of the machine.

- > Adjust the sitting height so that the knee lifter can be operated with the knee.



Fixing the touchscreen pen

- > Store the touchscreen pen at the magnet holder.



Switching the machine on

- > Switch on the machine at the main switch to «I».



2.3 Foot control

Regulating the speed via the foot control

Via the foot control the speed can be adjusted steplessly.

- > Press the foot control down carefully to start the machine.
- > To sew faster, press the foot control harder.

- > Release the foot control to stop the machine.



Raising/Lowering the needle

- > Sink the heel back on the foot control to raise/lower the needle.



2.4 Spool pin

Retractable spool pin

Lift the spool pin



With metallic or other special threads, it is recommend to use the retractable spool pin.

The retractable spool pin is necessary when several threads are sewn and it can also be used for bobbin winding while sewing.

- > Press on the retractable spool pin with the finger and let go.
 - The retractable spool pin appears automatically.



Inserting foam pad and thread spool

The foam pad prevents the thread from getting hooked at the retractable spool pin.

- > Place the foam pad on the retractable spool pin.
- > Place the thread spool on the spool pin.



Horizontal spool pin

Placing the foam pad, the thread spool and the thread disc

Spool discs hold the thread spool in place for proper release of thread from the spool. The thread disc is only used with the horizontal spool holder.

- > Place the foam pad on the spool holder.
- > Place the thread spool on the spool holder.



- > Position the appropriate spool disc on the spool holder so that there is no space between the spool disc and the thread spool.



Using a spool net

The spool net provides an even unwinding of the thread from the thread spool and prevents the thread from knotting and breaking.

- > Pull the spool net over the thread spool.



2.5 Free arm

The BERNINA 535 provides a solidly designed free arm which offers a lot of space for large project on the right of the needle.

2.6 Feed dog

Adjusting the feed dog

NOTICE

Inappropriate handling of the fabric



Damage of the needle and the stitch plate.

- > Let the sewing project be fed evenly.

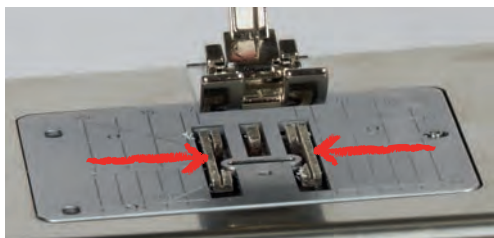
With each stitch, the feed dog moves forward by one step. The length of this step is determined by the stitch length selected.

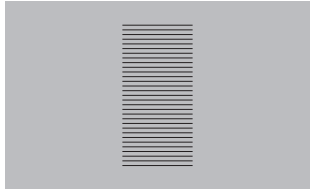

With a short stitch length, the steps are very short. For example when sewing buttonholes and satin stitches. The fabric is fed slowly under the presser foot, even when sewing at maximal speed.

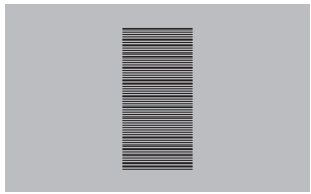
	<p>Let the fabric be fed evenly; this results in a more perfect stitch formation.</p>
	<p>Pulling or pushing the fabric will result in uneven stitches.</p>
	<p>Holding back the fabric will result in uneven stitches.</p>

- > Push the button «Feed dog up/down» to lower the feed dog.



- > Push the button again to sew with the feed dog up.

2.7 Slide-on table

Using the slide-on table

When attached to the free arm, it expands the already existing sewing area.

- > Raise the needle.
- > Raise the presser foot.
- > Switch the machine off and disconnect it from the power supply system.
- > Push the slide-on table to the right over the free arm until it engages.



- > To remove the slide-on table, press the button at the table down and pull the slide-on table over the free arm to the left.



2.8 Presser foot

Adjusting the presser position via the knee lifter of the Free Hand System

- > Adjust the sitting height so that the knee lifter can be operated with the knee.
- > Push the knee lifter with the knee to the right to raise the presser foot.

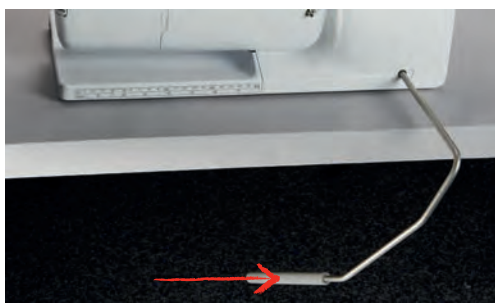

- Simultaneously the feed dog is lowered and the thread tension is released.
- > Release the knee lifter slowly to lower the presser foot.

Changing the presser foot

- > Raise the needle.
- > Raise the presser foot.
- > Switch the machine off and disconnect it from the power supply system.
- > Push the clamping lever up (1).
- > Remove the presser foot (2).



- > Guide the new presser foot upwards over the cone.
- > Press the clamping lever down.

Having the presser foot displayed in the user interface

The recommended presser foot for the selected stitch is displayed. In addition to that, optional presser feet can be displayed.

- > Switch the machine on.
- > Select a stitch pattern.
 - In the icon «Presser foot display» the recommended presser foot is indicated with a number.



- > Touch the icon «Presser foot display».
- > With the touchscreen pen/finger scroll up within the range of presser feet to have optional presser feet displayed.
- > If a presser foot is touched, the description and the application for this presser foot is displayed.



Adjusting the presser foot pressure

The factory-set standard presser foot pressure can be used for all common sewing works. When working with jersey fabrics or with loose knitware, reduce the presser foot pressure. For firm materials, increase the presser foot pressure.



The presser foot pressure is designed to adjust the pressure of the presser foot optimally to the fabric thickness. When working with thick fabrics, it is recommended to reduce the presser foot pressure. This provides the advantage that the presser foot is slightly lifted so that the fabric can be moved more easily. When working with thin fabrics, it is recommended to increase the presser foot pressure. This provides the advantage that the fabric cannot be moved too easily under the presser foot.

- > Turn the knob to the right to reduce the pressure foot pressure.
- > Turn the knob further to the right to raise the presser foot.
- > Turn the knob to the left to increase the pressure foot pressure.



2.9 Adjusting the feed dog



- > Touch the icon «Feed dog up/down.»
- > Raise or lower the feed dog according to the animation.

2.10 Needle and stitch plate

Changing the needle

- > Raise the needle.
- > Switch the machine off and disconnect it from the power supply system.
- > Remove the presser foot.
- > Loosen the fixing screw of the needle manually.



- > Pull the needle down.
- > Hold the new needle with the flat side to the back.
- > Insert the needle as far as it will go.
- > Tighten the fixing screw manually.

Selecting the needle in the User Interface

After having changed the needle, it can be checked whether or not it can be used in combination with the selected stitch plate.



- > Touch the icon «Stitch plate/Needle selection».



- > Select the inserted needle.

Select the needle type and the needle size

Convenient memory function: To prevent a loss of information, the needle type and the needle size can be saved additionally on the machine. The saved needle type and the saved needle size can be checked at any time.



- > Touch the icon «Stitch plate/Needle selection».



- > Touch the icon «Needle type/Needle size».
- > Select the needle type (1) of the inserted needle.
- > Select the needle size (2) of the inserted needle.



Adjusting the needle position up/down



- > Push the button «Needle up/down» to lower the needle.
- > Push the button «Needle up/down» again to raise the needle.

Adjusting the needle position left/right

There is a total of 11 needle positions. The needle position is indicated by the needle position number in the display.

- > Push the button «Needle left» (1) to move the needle to the left.
- > Push the button «Needle right» (2) to move the needle to the right.



Needle stop up/down (permanent)



- > Touch the icon «Needle stop up/down (permanent)» to fix the needle position permanently.
 - The machine stops with needle position down as soon as the foot control is released or the button «Start/Stop» has been pressed.

- > Touch the icon «Needle stop up/down (permanent)» again.
 - The machine stops with needle position up as soon as the foot control is released or the button «Start/Stop» has been pressed.

Changing the stitch plate

The stitch plate is marked with vertical, horizontal and diagonal lines in millimeters (mm) and inches (inch). These lines help to guide the fabric when sewing seams and precise topstitching.

Prerequisite:

- The feed dog is lowered.
 - The machine is switched off and disconnected from the power supply system.
 - Needle and presser foot are removed.
- > Press the stitch plate down at the mark back right until it flips up.



- > Remove the stitch plate.
- > Place the openings of the new stitch plate above the corresponding guide pins and press down until it clicks into place.

Selecting the stitch plate in the User Interface

After having changed the stitch plate, it can be checked whether or not it is suitable to be used in combination with the selected needle.



- > Touch the icon «Stitch plate/Needle selection».
- > Select the previously attached the stitch plate.

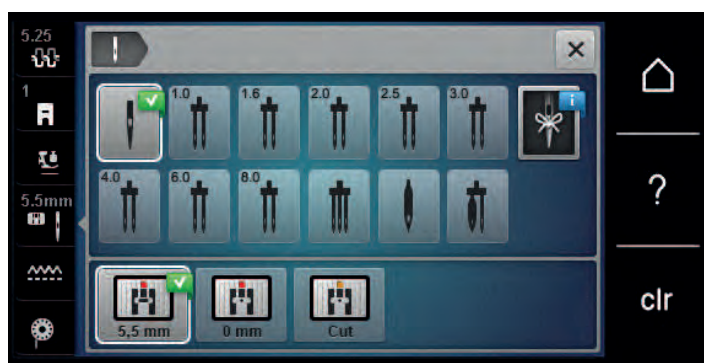

- If the selected stitch plate is suitable in combination with the needle, sewing can be started.
- If the selected stitch plate is not suitable in combination with the needle, starting the machine is automatically blocked.

2.11 Threading

Threading the upper thread

Prerequisite:

- The needle and the foot are raised.
 - The machine is switched off and disconnected from the power supply system.
- > Place the foam pad on the spool pin.
 > Place the thread spool on the spool pin so that the thread is unwound clockwise.
 > Add the appropriate spool disc.
 > Guide the thread in direction of the arrow through the rear thread guide (1) and hold the thread with the hands so that it is taut and can be inserted into the thread tension.
 > Guide the thread in direction of the arrow through the thread tension (2).

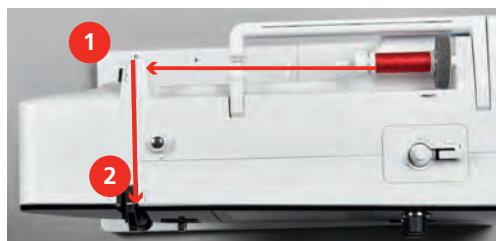

- > Guide the thread downwards around the thread take-up lever cover (3).
 > Guide the thread upwards and insert into the thread take-up lever (4).

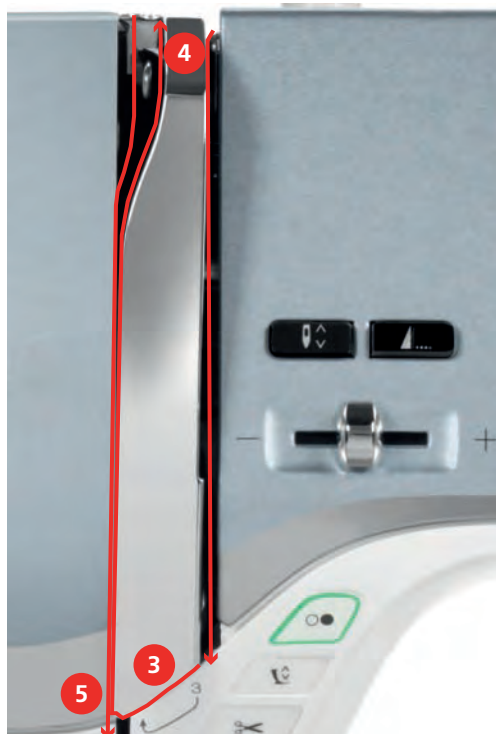

- > Guide the thread downwards again (5).

- > Guide the thread through the guides (6/7) above the foot.

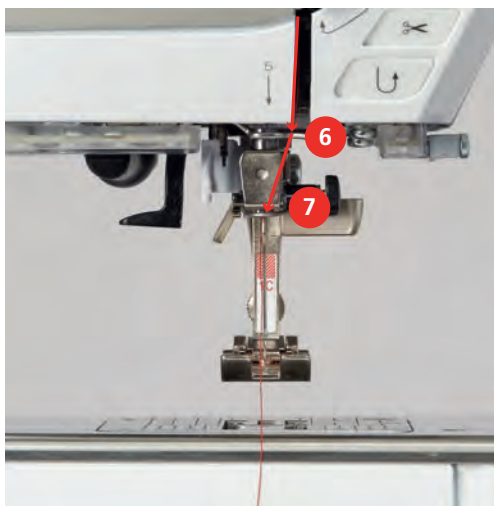

- > Switch the machine on.
- > Press the semi-automatic threader lever (8) slightly down, keep pressed and pull the thread to the left beneath the gray threader hook (9).

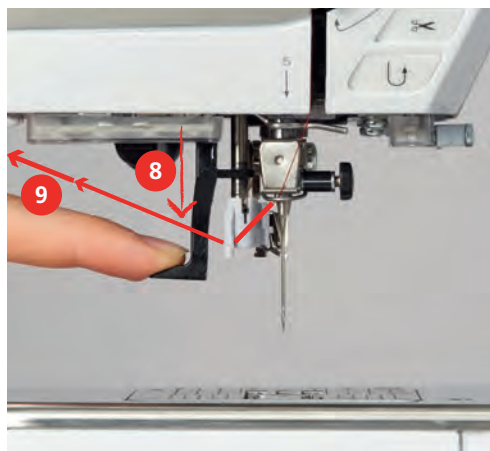

- > Guide the thread around the gray threader hook from the left to the right (11).
- > Press the threader lever down as far as it will go (10) and then pull the thread from the left to the right (11) through the threader slot (12) until it hooks into the small wire hook.
- > Pull the thread over the thread cutter (13) from the back and cut.

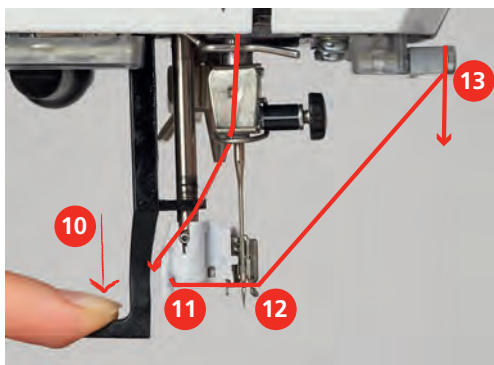

- > Release the lever to thread.

- > Pull the thread loop (14) to the back.

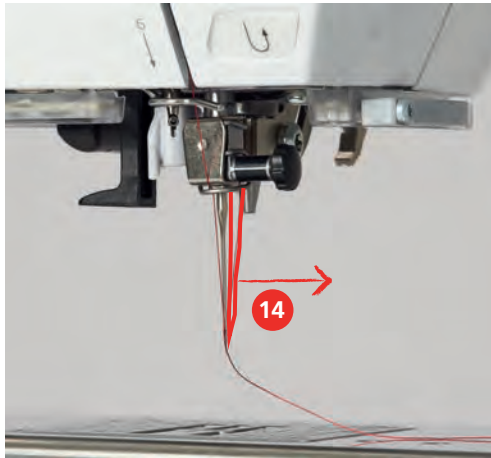

- > Pull the thread beneath the attached foot over the thread cutter (15) and cut.

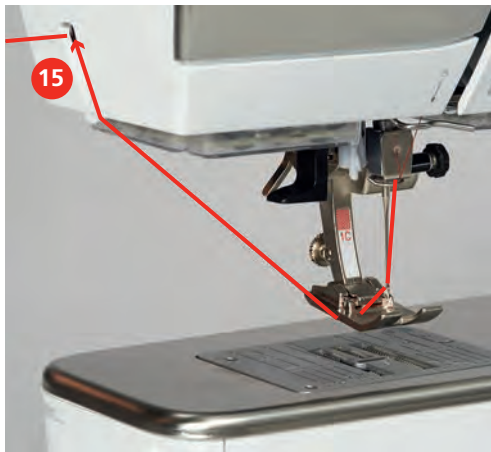

Threading the double needle

Prerequisite:

- The double needle is inserted.
- > Guide the first thread in direction of the arrow on the right side of the tension disc (1).
- > Guide the second thread in direction of the arrow on the left side of the tension disc (1).



- > Guide the first and the second thread to the thread guide above the needle.
- > Thread the first thread manually into the right needle.

- > Thread the second thread manually into the left needle.

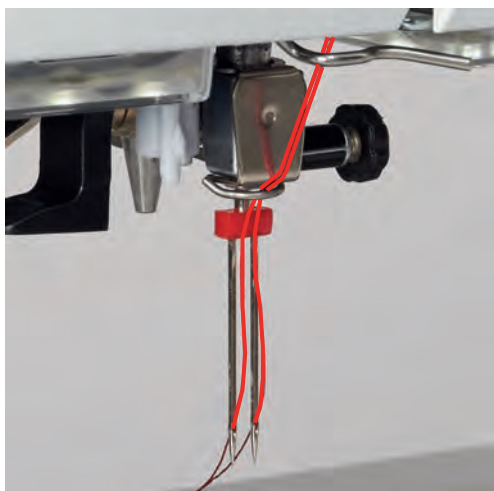

Threading the triple needle



Always insert a foam pad when using the retractable spool pin. It prevents the thread from getting hooked at the spool pin.

Prerequisite:

- The triple needle is inserted.
- > Place the foam pad, the thread spool and the appropriate spool disc on the spool pin.
- > Place the filled bobbin on the retractable spool pin.
- > Place the appropriate spool disc.
- > Place the thread spool.
- > Thread the 3 threads up to the upper thread guide.

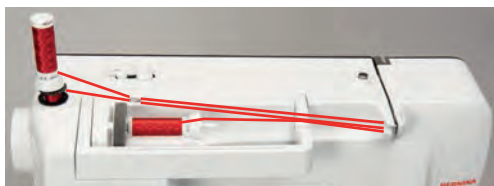

- > Guide 2 threads past the thread tension discs on the left and to the thread guide above the needle.
- > Guide 1 thread past the thread tension disc on the right and to the thread guide above the needle.
- > Thread the first thread into the left needle manually.
- > Thread the second thread into the center needle manually.
- > Thread the third thread into the right needle manually (see page 48).

Winding the bobbin thread



The bobbin thread can be wound while embroidering if the retractable spool pin is used for winding.

Prerequisite:

- The foam pad, the thread spool and the appropriate thread disc are positioned.
- > Attach the empty bobbin on the winding unit so that the silvery sensor surface is down.



- > Guide the thread to the left into the rear thread guide (1).
- > Guide the thread around the thread pretensioner clockwise (2).
- > Wind the thread clockwise 2 to 3 times around the empty bobbin (3).
- > Pull the thread over the thread cutter at the engaging lever (4) and cut.

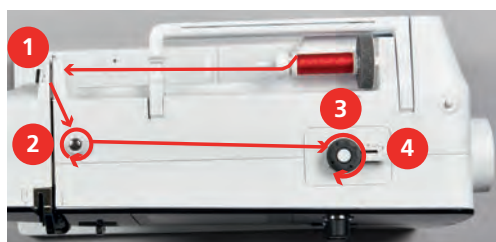

- > Push the engaging lever (5) towards the bobbin.



- The machine winds and the display to wind the bobbin appears.
- > Move the slide on the display using the touchscreen pen or the finger to adjust the winding speed.
- > To stop the winding process, the engaging lever must be pressed to the right.
- > Push the engaging lever towards the bobbin again to continue the winding process.
 - As soon as the bobbin is full, the machine stops the winding process automatically.
- > Remove the bobbin and cut the thread using the thread cutter at the engaging lever.

Threading the bobbin thread

Prerequisite:

- The needle is raised.
- The machine is switched off and the bobbin cover is opened.

- > Press the bobbin case release at the bobbin case (1).



- > Remove the bobbin case.
- > Remove the bobbin from the bobbin case.
- > Insert the new bobbin so that the silvery sensor surface is facing the back of the bobbin case.



- > Pull the thread into the slot (2) from the left.



- > Pull the thread to the right under the spring (3), then lead the thread under the two thread guides (4) and pull upwards.



- > When inserting into the machine, hold the bobbin case so the the thread guide (5) points upwards.



- > Insert the bobbin case.
- > Press onto the center of the bobbin case until it engages.
- > Pull the thread through the thread cutter (6) and cut.

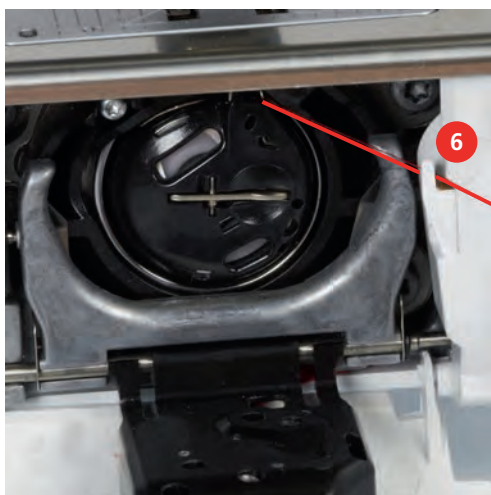

- > Close the bobbin cover.

Instruction how to thread the bobbin thread



- > Touch the icon «Filling level bobbin thread».
- > Thread the bobbin thread according to the animation.



3 Setup Program

3.1 Sewing settings

Adjusting the upper thread tension

Adjustments to the upper thread tension in the Setup Program affect all stitch patterns. Individual alterations of the upper thread tension can also be made for currently selected stitches. The setting in the Setup remains active after switching off.



> Touch the icon «Home».



> Touch the icon «Setup Program».



> Touch the icon «Sewing settings».



> Touch the icon «Alter the upper thread tension».
> Move the slide using the touchscreen pen/finger or touch the icons «+» or «-» to alter the upper thread tension.

Adjusting the maximum sewing speed

By using this function, the maximum speed can be reduced.



> Touch the icon «Home».



> Touch the icon «Setup Program».



> Touch the icon «Sewing settings».



> Touch the icon «Alter the maximum speed».
> Move the slide using the touchscreen pen/finger or touch the icons «+» or «-» to alter the maximum speed.

Programming securing stitches

If the function is activated, 4 securing stitches are sewn automatically at the pattern start after the thread cut.



> Touch the icon «Home».



> Touch the icon «Setup Program».



> Touch the icon «Sewing settings».



> Touch the switch using the touchscreen pen/finger to deactivate the securing stitches.
> Touch the switch again to activate the securing stitches.

Programming the button «Thread cutter»

The automatic securing can be programmed before the thread cut takes place.



> Touch the icon «Home».



> Touch the icon «Setup Program».



> Touch the icon «Sewing settings».



> Touch the icon «Program buttons and icons».



> Touch the icon «Program the button thread cutter».



> Touch the icon «Securing» to sew 4 securing stitches in place.



> Touch the icon «Alter the number of securing stitches» to program the number of securing stitches in close succession.
> Touch the icons «-» or «+» to program the number of securing stitches.

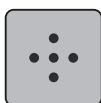

> Touch the icon «Securing stitches in place» to program 4 securing stitches in place.



> Touch the icon «Securing» to deactivate the automatic securing.
> Touch the icon «Securing» again to activate the automatic securing.

Programming the button «Securing»

Number and type of securing stitches can be programmed.



> Touch the icon «Setup Program».



> Touch the icon «Sewing settings».



> Touch the icon «Program buttons and icons».



> Touch the icon «Program the securing button».



> Touch the icon «Alter the number of securing stitches» to program subsequent securing stitches.

> Touch the icons «-» or «+» to program the number of securing stitches.

> Touch the yellow-framed icon to reset the alterations to default setting.

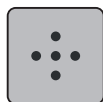

> Touch the icon «Securing stitches in place» to program 4 securing stitches in place.

Programming the button «Quick reverse»

It can be chosen either «Quick reverse permanent» or «Backstepping».



> Touch the icon «Home».



> Touch the icon «Setup Program».



> Touch the icon «Sewing settings».



> Touch the icon «Program buttons and icons».



> Touch the icon «Program Quick reverse».



> Touch the icon «Backstepping» to activate backstepping.

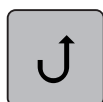

> Touch the icon «Quick reverse permanent» to activate the permanent reverse sewing.

3.2 Embroidery settings

Adjusting the upper thread tension

Alterations of the upper thread tension in the Setup Program affect all embroidery motifs. The settings in the Setup Program remain active even after switching the machine off.



> Touch the icon «Home».



- > Touch the icon «Setup Program».



- > Touch the icon «Embroidery settings».



- > Touch the icon «Alter the upper thread tension».
- > Move the slide using the touchscreen pen/finger or touch the icons «+» or «-» to alter the upper thread tension.
- > Touch the yellow-framed icon to reset the alterations to default setting.

Adjusting the maximum embroidering speed

By using this function, the maximum speed can be reduced.



- > Touch the icon «Home».



- > Touch the icon «Setup Program».



- > Touch the icon «Embroidery settings».



- > Touch the icon «Alter the maximum speed».
- > Move the slide using the touchscreen pen/finger or touch the icons «+» or «-» to alter the maximum speed.
- > Touch the yellow-framed icon to reset the alteration to default setting.

Centering the embroidery motif or opening in original position

When the embroidery motif is opened on the machine, it is always centered to the embroidery hoop. If you want the embroidery motif to be opened in its original position (defined by the BERNINA embroidery software), the function «Center the embroidery motif» must be activated.



- > Touch the icon «Home».



- > Touch the icon «Setup Program».



- > Touch the icon «Embroidery settings».



- > Touch the icon «Center the embroidery motif».



- > Press the switch in the right section.
 - A previously moved embroidery motif which has been saved in the new position is opened in the saved position after selecting.

- > Press the switch in the right section again.
 - The embroidery motif is centered to the embroidery hoop.

Calibrating the hoop

The calibration of the embroidery hoop is the coordination of the needle to the center of the embroidery hoop.

Prerequisite:

- The embroidery module is connected and the embroidery hoop with the appropriate embroidery template is attached.



- > Touch the icon «Home».



- > Touch the icon «Setup Program».



- > Touch the icon «Embroidery settings».



- > Touch the icon «Calibrate the hoop».
- > Center the needle via the arrow icons on the display.

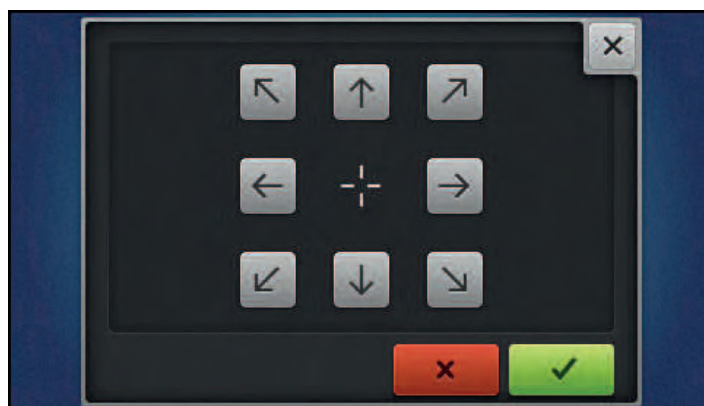

Entering the fabric thickness

If the fabric thickness, as for e.g. toweling is more than 4 mm (0.15 inch) it is recommended to select 7.5 mm (0.29 inch) or 10 mm (0.39 inch). The thicker the fabric, the slower the embroidery speed of the machine. When the machine is switched off, the alterations are reset to the default setting 4 mm (0.15 inch).



- > Touch the icon «Home».



- > Touch the icon «Setup Program».



- > Touch the icon «Embroidery settings».



- > Touch the icon «Select fabric thickness».
- > Select fabric thickness.

Programming securing stitches (Smart Secure)

Embroidery motifs are programmed either with or without securing stitches. The machine recognizes when no securing stitches are programmed and adds some.



- > Touch the icon «Home».



- > Touch the icon «Setup Program».



- > Touch the icon «Embroidery settings».



- > Touch the icon «Securing stitches on/off».



- > Press the switch in the upper right section to deactivate the securing stitches at the start.
 - If the embroidery motif has programmed securing stitches, they will be embroidered.
 - If the embroidery motif doesn't have any programmed securing stitches, none are embroidered.
- > Press the switch again to activate the securing stitches at the start.
 - If the embroidery motif has programmed securing stitches, they will be embroidered.
 - If the embroidery motif doesn't have any programmed securing stitches, the securing stitches are added and will be embroidered.
- > Press the switch in the lower right section to deactivate the securing stitches at the end.
 - If the embroidery motif has programmed securing stitches, they will be embroidered.
 - If the embroidery motif doesn't have any programmed securing stitches, none are embroidered.
- > Press the switch again to activate the securing stitches at the end.
 - If the embroidery motif has programmed securing stitches, they will be embroidered.
 - If the embroidery motif doesn't have any programmed securing stitches, the securing stitches are added and will be embroidered.

Adjusting the thread cut

The settings for the thread cut can be customized. Deactivate the thread cut after a color change (1) or adjust the length of the connecting stitch (3). The machine does the cutting of the connecting threads at the determined length for you. Please adjust the length first from where the connecting stitches are to be cut. Then select the embroidery motif.





The length of the connecting thread can be adjusted between 1 mm and 15 mm, the default setting is 6 mm. This means that all connecting stitches longer than 6 mm are cut automatically. If the value is reduced to 1 mm, more thread cuts are carried out, it takes longer to embroider and more loose thread ends can be seen on the wrong side of the fabric. On the right side of the fabric there will be practically none or merely very short connecting stitches which results in a wonderful stitch formation. Reducing the length of the thread cut to 1 mm is particularly of advantage when embroidering texts where usually many short connecting threads occur. As for other embroidery motifs (specifically when both sides of the embroidery motifs are visible) it may be reasonable to not reduce the length of the thread cut so much so that there won't be too many loose thread ends on the wrong side of the fabric. Loose ends get sewn over and can hardly be removed afterwards.



> Touch the icon «Home».



> Touch the icon «Setup Program».



> Touch the icon «Embroidery settings».



> Touch the icon «Thread cut settings».



- > Touch the switch in the upper portion of the display (1) to deactivate the automatic thread cut after the thread has been changed.
- > Touch the switch in the upper portion of the display (1) again to activate the automatic thread cut after the thread has been changed.
- > Touch the switch in the middle section of the display (2) again and the machine won't stop for a manual thread cut.
- > Touch the switch in the middle section of the display (2) again so that the machine will stop after about 7 stitches and the remaining thread can be cut manually.
- > Touch the icons «-» or «+» (3) to adjust the length from where the connecting stitches are cut.



> Touch the yellow-framed icon to reset the alterations to default setting.

Changing the measuring unit

The measuring unit in the embroidery mode can be changed from mm to inch. The standard setting is in mm.



> Touch the icon «Home».



> Touch the icon «Setup Program».



> Touch the icon «Embroidery settings».



- > Touch the icon «Change measuring unit».
- > Touch the icon «Inch» (1) to change the measuring unit in the embroidery mode to inch.
- > Touch the icon «mm» (2) to change the measuring unit in the embroidery mode to mm.



3.3 Selecting personal settings



> Touch the icon «Home».



> Touch the icon «Setup Program».



- > Touch the icon «Personal settings».
- > Select the desired color of the display and the background.
- > Touch the text box above the color settings.



- > Enter the welcome text.
- > Touch the icon «ABC» (standard setting) to use upper-case letters.

- > Touch the icon «abc» to use lower-case letters.
- > Touch the icon «123» to use figures and mathematical symbols.
- > Touch the icon «@&!» to use special characters.
- > Touch the text box above the keyboard to delete the entered text completely.
- > Touch the icon «DEL» to delete individual characters of the entered text.



- > Touch the icon «Confirm».

3.4 Monitoring functions

Activating the upper thread indicator



- > Touch the icon «Home».



- > Touch the icon «Setup Program».



- > Touch the icon «Monitoring settings».



- > Touch the switch in the right portion of the display to deactivate the upper thread indicator.
- > Touch the switch again to activate the upper thread indicator.

3.5 Activating the audio signals



- > Touch the icon «Home».



- > Touch the icon «Setup Program».



- > Touch the icon «Audio signals».
- > Touch the switch (1) to deactivate any audio signals in general.
- > Touch the switch (1) again to activate any audio signals in general.
- > In the section (2) touch the icons «1 – 4» to set up the desired signal for the selection of a stitch pattern.
- > In the section (2) touch the icon «Loudspeaker» to deactivate the signal for the selection of a stitch pattern.
- > In the section (3) touch the icons «1 – 4» to activate the signal for the selection of functions.



- > In the section (3) touch the icon «Loudspeaker» to deactivate the signal for the selection of functions.



- > In the section (4) touch the icon «Loudspeaker» to deactivate the signal when using the BSR modes.

- > In the section (4) touch the icon «Loudspeaker» again to activate the signal when using the BSR modes.



3.6 Machine settings

Selecting a language

The User Interface can be programmed in different languages according to the customer's wish because BERNINA provides a wide range of international languages for the customers. Via firmware updates new languages are provided for the User Interface as appropriate.



- > Touch the icon «Home».



- > Touch the icon «Setup Program».



- > Touch the icon «Machine settings».



- > Touch the icon «Language selection».
- > Select a language.

Adjusting the brightness of the display

The brightness of the display can be adjusted corresponding to the personal preferences.



- > Touch the icon «Home».



- > Touch the icon «Setup Program».



- > Touch the icon «Machine settings».



- > Touch the icon «Adjust the brightness».
- > Move the slide in the upper portion of the display using the touchscreen pen/finger or touch the icons «+» or «-» to alter the brightness of the display.

Adjusting the sewing light

The brightness of the sewing light can be adjusted corresponding to the personal preferences.



> Touch the icon «Home».



> Touch the icon «Setup Program».



> Touch the icon «Machine settings».



> Touch the icon «Adjust the brightness».

> Move the slide in the upper portion of the display using the touchscreen pen/finger or touch the icons «+» or «-» to alter the brightness of the sewing light.



> Touch the switch to switch the sewing light off.

> Touch the switch again to switch the sewing light on.

Checking the firmware version

Both the firmware and the hardware version of the machine and the attached embroidery module are displayed.



> Touch the icon «Home».



> Touch the icon «Setup Program».



> Touch the icon «Machine settings».



> Touch the icon «Information».



> Touch the icon «Firmware and Hardware Information».

Reviewing the total number of stitches

The total number of stitches of the machine as well as the number of stitches since the last service carried out by the specialized BERNINA dealer are displayed.



> Touch the icon «Home».



> Touch the icon «Setup Program».



> Touch the icon «Machine settings».



> Touch the icon «Information».



> Touch the icon «Firmware and Hardware Information».

Registering details of the dealer

The contact details of your specialized BERNINA dealer can be registered.



> Touch the icon «Home».



> Touch the icon «Setup Program».



> Touch the icon «Machine settings».



> Touch the icon «Information».



> Touch the icon «Dealer details» to enter the information of the specialized dealer.



> Touch the icon «Name of the shop» to enter the name of the specialized BERNINA dealer.



> Touch the icon «Address» to enter the address of the specialized BERNINA dealer.



> Touch the icon «Phone» to enter the telephone number of the specialized BERNINA dealer.



> Touch the icon «Internet» to enter the Internet homepage or the email address of the specialized BERNINA dealer.

Saving Service data

Service data concerning the status quo of the machine can be saved on a BERNINA USB stick (optional accessory) and then given to the BERNINA dealer.

> Insert a BERNINA USB stick (Optional accessory) which provides enough free memory space into the USB port.



> Touch the icon «Home».



> Touch the icon «Setup Program».



> Touch the icon «Machine settings».



> Touch the icon «Information».



> Touch the icon «Service data».

> Touch the icon «LOG».

– The icon «LOG» is outlined in white.

> Only when the icon is not outlined in white anymore, remove the BERNINA USB Stick (optional accessory).

Back to basic setting

ATTENTION: Using this function will delete all individually made settings.



> Touch the icon «Home».



> Touch the icon «Setup Program».



> Touch the icon «Machine settings».



> Touch the icon «Default settings».



> Touch the icon «Default setting sewing».



> Touch the icon «Confirm» to restore the default settings for the sewing settings.



> Touch the icon «Default setting embroidery».



> Touch the icon «Confirm» to restore the default settings for the embroidery settings.



> Touch the icon «Default setting all».



> Touch the icon «Confirm» to restore all default settings.

Deleting user data

Motifs which are not needed anymore can be deleted so that there will be more capacity for new motifs.



> Touch the icon «Home».



> Touch the icon «Setup Program».



> Touch the icon «Machine settings».



> Touch the icon «Default settings».



> Touch the icon «Delete data from the personal memory».



> Touch the icon «Confirm» to delete all data from the personal memory.



> Touch the icon «Delete personal embroidery motifs».



> Touch the icon «Confirm» to delete all embroidery motifs from the personal memory.

Deleting motifs on the BERNINA USB Stick

When motifs which won't be needed anymore are saved on the BERNINA USB Stick (Optional accessory), the stick can be connected to the machine and the data can be deleted.

> Insert the BERNINA USB Stick (Optional accessory) into the den USB port of the machine.

> Touch the icon «Home».



> Touch the icon «Setup Program».



> Touch the icon «Machine settings».



> Touch the icon «Default settings».



> Touch the icon «Delete data from USB Stick».



> Touch the icon «Confirm» to delete all data on the BERNINA USB Stick (optional accessory).

Calibrating the Buttonhole foot No. 3A

The Buttonhole foot No. 3A is calibrated to this machine and they should only be used both together.

Prerequisite:

- The Buttonhole foot No. 3A is attached.
- The needle is not threaded.



> Touch the icon «Home».



> Touch the icon «Setup Program».



> Touch the icon «Machine settings».



> Touch the icon «Maintenance/Update».



> Touch the icon «Calibrate the Buttonhole foot with slide No.3A».



> Touch the button «Start/Stop» to start the calibration.

Updating the machine Firmware

NOTICE

BERNINA USB stick (optional accessory) has been removed too early

Firmware has not been updated and the machine cannot be used.

- > Remove the BERNINA USB stick (optional accessory) only after the update has been completed successfully.

The latest firmware of the machine and a detailed step-by-step instruction for updating processes can be downloaded at www.bernina.com. In general, personal data and settings are automatically transferred during a firmware update. For reasons of safety, it is also recommended to save data and settings on a BERNINA USB stick (optional accessory) before the firmware update is started. If personal data and settings should get lost during a firmware update, they can be transferred to the machine again afterwards.

- > Insert the BERNINA USB Stick (optional accessory), FAT32 formatted, providing the latest software into the port.



> Touch the icon «Home».



> Touch the icon «Setup Program».



> Touch the icon «Machine settings».



> Touch the icon «Maintenance/Update».



> Touch the icon «Update the machine».



> Touch the icon «Save data on USB Stick».
– The icon is checkmarked in green.

Update

> Touch the icon «Update» to start the update of the firmware.

Recovering saved data

NOTICE

The BERNINA USB stick (optional accessory) has been removed too early.

Saved data cannot be transferred and the machine cannot be used.

> Remove the BERNINA USB stick (optional accessory) only after the saved data has been transferred successfully.

If personal data and settings after a software update are not available anymore, they can be transferred to the machine again afterwards.

> Insert the BERNINA USB stick (Optional accessory) providing the saved data and settings into the USB port of the machine.



> Touch the icon «Home».



> Touch the icon «Setup Program».



> Touch the icon «Machine settings».



> Touch the icon «Maintenance/Update».



> Touch the icon «Update the machine».



> Touch the icon «Transfer saved data to machine».
– The icon is checkmarked in green.

Cleaning the thread catcher

In chapter «Maintenance and cleaning» there are additional illustrated step-by-step instructions.



> Touch the icon «Home».



> Touch the icon «Setup Program».



> Touch the icon «Machine settings».



> Touch the icon «Maintenance/Update».



> Touch the icon «Clean the thread catcher».
> Clean the thread catcher according to the instructions on the display.

Lubricating the machine



Electronically driven components

Risk of injury near the needle and the hook.

> Switch the machine off and disconnect it from the power supply system.



Lubricating the hook

Too much oil can pollute the fabric and the thread.

> Always sew/embroider a test sample first.

The Setup Program provides animations how to oil the machine. In chapter «Maintenance and cleaning» there are more illustrated step-by-step instructions. Always use BERNINA oil to lubricate.



> Touch the icon «Home».



> Touch the icon «Setup Program».



> Touch the icon «Machine settings».



> Touch the icon «Maintenance/Update».



> Touch the icon «Lubricate the machine».
> Lubricate the machine according to the instructions on the display.

Packing the embroidery module

To pack the embroidery module into the original packaging without moving the embroidery arm manually, the embroidery arm needs to be brought to its packing position.

Prerequisite:

- The embroidery module is connected with the machine.



> Touch the icon «Home».



> Touch the icon «Setup Program».



> Touch the icon «Machine settings».



> Touch the icon «Maintenance/Update».



> Touch the icon «Packing position for embroidery module».
> Follow the instructions on the display.

4 System settings

4.1 Calling up the Tutorial

The tutorial provides information and explanations on different sections concerning sewing and embroidering and the various stitches.



- > Touch the icon «Home».



- > Touch the icon «Tutorial».
- > Select the desired topic to get information.

4.2 Calling up the Creative Consultant

The Creative Consultant provides information about decision support concerning sewing projects. After entering the fabric and the desired sewing project, suggestions for suitable needles, presser feet etc. are displayed.

Prerequisite:

- Sewing mode is active.



- > Touch the icon «Home».



- > Touch the icon «Creative Consultant».
- > Select the fabric to be sewn.
- > Select the sewing project.

4.3 Using eco mode

During a longer interruption of work the machine can be set into a power save mode. The power save mode also serves as a child safety feature. Nothing can be selected in the display and the machine cannot be started.



- > Touch the icon «Home».



- > Touch the icon «eco-Modus».
 - The display goes to sleep. The power consumption is reduced and the sewing light is off.
- > Touch «eco».
 - The machine is ready for use.

4.4 Calling up the Help



- > Touch the window in the display where help is needed.
- > Touch the icon «Help» to start the help mode.
- > Touch the icon in the display where help is needed.
 - Assistance concerning the selected icon is displayed.

4.5 Cancelling any alterations with «clr»

Any alterations to motifs can be reset to default setting. Exceptions are saved motifs which have been filed in the personal memory and monitoring functions.



- > Touch the icon «clr».

5 Creative sewing

5.1 Overview selection menu sewing

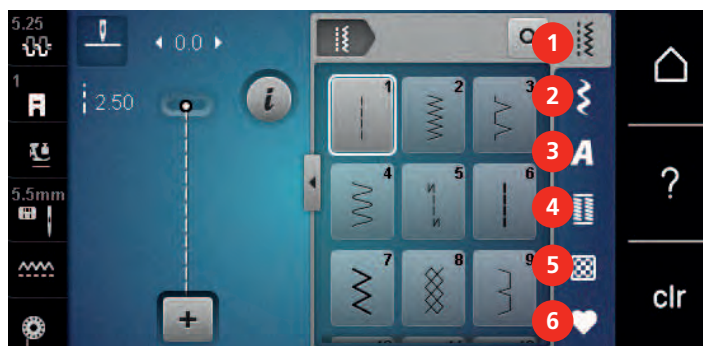

- | | | | |
|---|---------------------|---|-----------------|
| 1 | Practical stitches | 4 | Buttonholes |
| 2 | Decorative stitches | 5 | Quilt stitches |
| 3 | Alphabets | 6 | Personal Memory |

Selecting a stitch pattern

- > Select a stitch pattern, an alphabet or a buttonhole.
- > With the touchscreen pen/finger scroll up within the range of the practical stitches to have more stitch patterns displayed.
- > Touch the icon «Display all the stitch patterns» (1) to scale up the view.
- > Touch the icon «Display all the stitch patterns» (1) again to downsize the stitch pattern view.

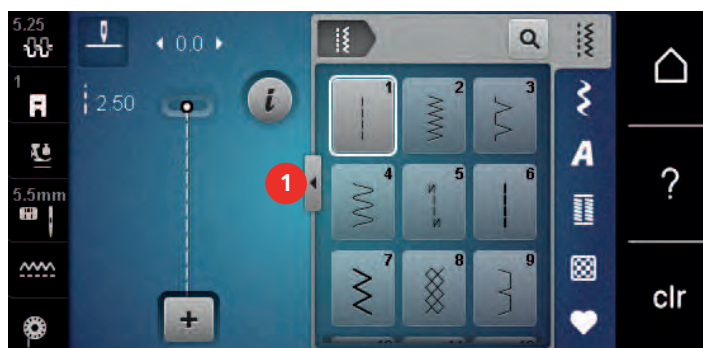

- > Touch the icon «Stitch pattern number entry» to select the stitch pattern via entering the stitch number.

5.2 Regulating the speed

The speed is infinitely variable with the slide-speed control.



- > Move the slide-speed control to the left to reduce the speed.
- > Move the slide-speed control to the right to increase the speed.

5.3 Adjusting the upper thread tension

The default setting of the upper thread tension is provided automatically as soon as a stitch pattern or an embroidery motif is selected.

The upper thread tension is set optimally at the BERNINA factory and the machine has been tested. Metrosene-/Seralon thread size 100/2 (Company Mettler, Switzerland) is used for upper and bobbin thread.

When of using other types of sewing threads, the optimal upper thread tension may vary. Therefore it may be necessary to adjust the upper thread tension individually according to the sewing project as well as the desired stitch pattern.

The higher the upper thread tension, the tighter the upper thread which means that the bobbin thread is pulled up to the top of the fabric. When the upper thread tension is low, the upper thread is less tightened which means that the bobbin thread is pulled up less.

Alterations of the upper thread tension affect the currently selected stitch pattern and all embroidery motifs. Permanent alterations of the upper thread tension for the sewing mode (see page 54) can be made in the Setup Program.

Prerequisite:

- In the Setup Program the upper thread tension has been altered.
- > Touch the icon «Upper thread tension».
- > Move the slide using the touchscreen pen/finger to increase or reduce the upper thread tension.



- > Touch the yellow-framed icon on the right to reset the alterations to default setting.
- > Touch the yellow-framed icon on the left to reset the alterations to default setting in the **Setup Program**.

5.4 Editing stitch patterns

Changing the stitch width

- > Turn the «Upper Multifunctional knob» to the left to narrow the stitch width.
- > Turn the «Upper Multifunctional knob» to the right to widen the stitch width.
- > Touch the icon «Stitch width» (1).

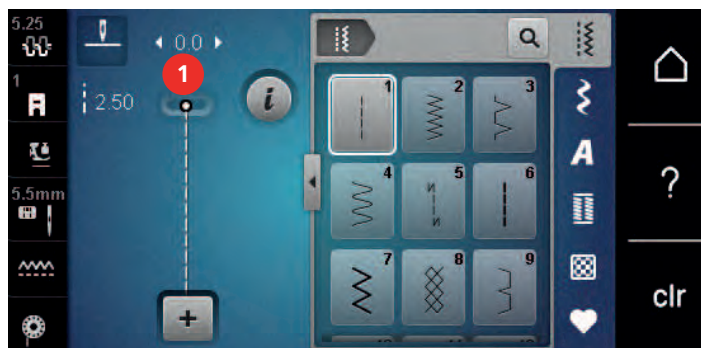

- > Touch the yellow-framed icon to reset the alteration to default setting.

Changing the stitch length

- > Turn the «Lower Multifunctional knob» to the left to shorten the stitch length.
- > Turn the «Lower Multifunctional knob» to the right to elongate the stitch length.

- > Touch the icon «Stitch length» (1).

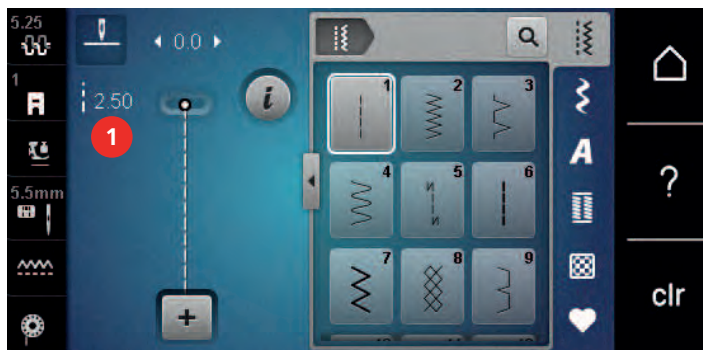

- > Touch the yellow-framed icon to reset the alteration to default setting.

Correcting the balance

The machine is tested and set optimally before it leaves the BERNINA factory. Different fabrics, threads and stabilizers can affect the programmed stitch patterns so that they cannot be sewn out correctly. The electronic balance can correct these deviation and the stitch pattern can be adjusted optimally to the selected fabric.

- > Select a stitch pattern or alphabet.
- > Touch the icon «i»-Dialog.



- > Touch the icon «Balance».
- > Turn the «Lower Multifunction knob» to correct the vertical direction of the stitch pattern.

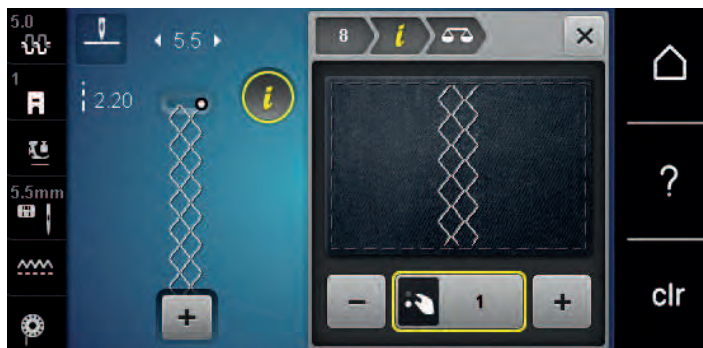

Programming pattern repeat

Stitch patterns can be repeated up to 9 times.

- > Select a stitch pattern or an alphabet.
- > Touch the icon «i»-Dialog.



- > Touch the icon «Pattern repeat» once to repeat the stitch pattern.
- > Touch the icon «Pattern repeat» again to repeat the stitch pattern up to 9 times.
- > Keep the icon «Pattern repeat» pressed to deactivate the stitch pattern repeat.

Mirror image of stitch patterns



- > Select a stitch pattern or alphabet.
- > Touch the icon «i»-Dialog.



- > Touch the icon «Mirror image left/right» to mirror the stitch pattern from left to right.



- > Touch the icon «Mirror image up/down» to mirror the stitch pattern contrary to the sewing direction.
- > Touch the yellow-framed icon to reset the alteration to default setting.

Quick reverse

- > Select a stitch pattern, alphabet or buttonhole.
- > Program needle stop down (permanent) to switch immediately to Quick reverse as soon as the button «Quick reverse» is pressed.
- > Program needle stop up (permanent) to sew another stitch forward before the machine switches to reverse sewing.

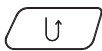

- > Push the button «Quick reverse» and keep pressed.

Permanent Quick reverse

- > Select a stitch pattern or alphabet.
- > Touch the icon «i»-Dialog.

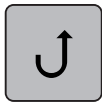

- > Touch the icon «Permanent reverse sewing» to sew permanently in reverse.

Backstepping

- > Select a stitch pattern, alphabet or buttonhole.
- > Touch the icon «i»-Dialog.



- > Touch the icon «Backstepping» to backstep the last 200 stitches.

5.5 Combining stitch patterns

Overview Combi mode



- | | | | |
|---|--|---|--|
| 1 | Stitch width of the active stitch pattern | 3 | Combi mode/Single mode |
| 2 | Stitch length of the active stitch pattern | 4 | Individual stitch pattern within a combination |

Creating Stitch pattern combinations

In the Combi mode stitch patterns and alphabets can be combined according to your wish. By combining any alphabet letters, the logo BERNINA can be created.



- > Touch the icon «Single/Combi mode».
- > Select the desired stitch patterns.



- > Touch the icon «Single/Combi mode» again to return to the single mode.

Saving a stitch pattern combination

- > Create a stitch pattern combination.
- > Touch the icon «Personal memory».



- > Touch the icon «Save stitch pattern».



- > Touch the icon «Confirm» or the yellow-framed icon to save the stitch pattern combination.

Loading a stitch pattern combination



- > Touch the icon «Single/Combi mode».



> Touch the icon «Personal memory».



> Touch the icon «Selection of stitch pattern combination».
> Select a stitch pattern combination.

Overwriting a stitch pattern combination

> Create a stitch pattern combination.
> Touch the icon «Personal memory».



> Touch the icon «Save stitch pattern».
> Select the stitch pattern combination which is to be overwritten.



> Touch the icon «Confirm» to overwrite the stitch pattern combination.

Deleting a stitch pattern combination

> Create a stitch pattern combination.
> Touch the icon «i»-Dialog.



> Touch the icon «Editing the whole combination».



> Touch the icon «Delete».



> Touch the icon «Confirm».

Editing a single stitch pattern

> Create a stitch pattern combination.
> With the touchscreen pen/finger touch the desired position (1) within the stitch pattern combination to select a single stitch pattern.



> Touch the icon «i»-Dialog to edit the single stitch pattern.

Deleting a single stitch pattern

- > Create a stitch pattern combination.
- > With the touchscreen pen/finger touch the desired position (1) within the stitch pattern combination to select a single stitch pattern.



- > Touch the icon «i»-Dialog.



- > Touch the icon «Delete» to delete the individual stitch pattern or
- > touch the desired stitch pattern (1) with the touchscreen pen/finger, keep it touched and move it outwards.
 - The stitch pattern is deleted.



Adding a single stitch pattern

The new stitch pattern is always inserted **after** the selected stitch pattern.

- > Create a stitch pattern combination.
- > With the touchscreen pen/finger touch the desired position (1) within the stitch pattern combination to select a single stitch pattern.



- > Select a new stitch pattern.

Mirroring a stitch pattern combination



- > Creating a stitch pattern combination.
- > Touch the icon «i»-Dialog.

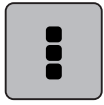

- > Touch the icon «Edit the whole combination».



- > Touch the icon «Mirror image left/right» to mirror the whole stitch pattern combination from the left to the right.
- > Touch the icon «Mirror image left/right» again to reset the alterations to default setting.

Stitch pattern combination Subdivider 1

A stitch pattern combination can be subdivided into several sections. The subdivision is placed **beneath** the cursor. Only this section is sewn where the cursor is placed. To sew the next section, the cursor must be placed in the next section.

- > Create a stitch pattern combination.
- > With the touchscreen pen/finger select the desired position within the stitch pattern combination where the stitch pattern combination is to be subdivided.
- > Touch the icon «i»-Dialog.

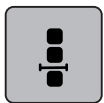

- > Touch the icon «Edit combination at cursor position».

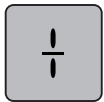

- > Touch the icon «Combination subdivider».

Stitch pattern combination Subdivider 2

A stitch pattern combination can be interrupted at several positions. The interruption is placed **beneath** the cursor.

- > Create a stitch pattern combination.
- > With the touchscreen pen/finger select the desired position within the stitch pattern combination where the stitch pattern combination is to be interrupted.
- > Touch the icon «i»-Dialog.

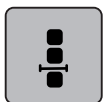

- > Touch the icon «Edit combination at cursor position».

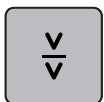

- > Touch the icon «Combination subdivider 2».
- > Sew the first section and then reposition the fabric.

Securing a stitch pattern combination

- > Create a stitch pattern combination.
- > With the touchscreen pen/finger select the desired position within the stitch pattern combination where the stitch pattern combination is to be secured.
- > Touch the icon «i»-Dialog.

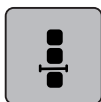

- > Touch the icon «Edit combination at cursor position».



- > Touch the icon «Securing».
 - Every single pattern of the stitch pattern combination can be secured at the start or at the end.

Programming pattern repeat

- > Create a stitch pattern combination.
- > Touch the icon «i»-Dialog.

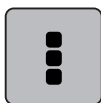

- > Touch the icon «Edit the complete combination».



- > Touch the icon «Pattern repeat» once to repeat the stitch pattern combination.
- > Touch the icon «Pattern repeat» again to repeat the stitch pattern combination up to 9 times.
- > Keep the icon «Pattern repeat» pressed to deactivate the pattern repeat.

5.6 Administering stitch patterns

Saving settings of stitch patterns

- > Select a stitch pattern, alphabet or buttonhole.
- > Touch the icon «i»-Dialog.
- > Edit the stitch, alphabet or buttonhole.



- > Touch the icon «Saving stitch pattern settings» to save the alterations permanently.



- > Touch the icon «Back to default setting» to cancel the alterations.

Saving stitch patterns in personal memory

In the filing system «Personal memory» any stitch patterns, also those which have been individually edited, can be saved.

- > Select a stitch pattern, alphabet or buttonhole.
- > Edit the stitch pattern.



> Touch the icon «Personal memory».



> Touch the icon «Save stitch pattern».
> Select the file where the pattern is to be saved.



> Touch the icon «Confirm».

Overwriting stitch patterns from the personal memory

Prerequisite:

- The stitch pattern is saved in the personal memory.

> Select a stitch pattern, alphabet or buttonhole.
> Edit the stitch pattern.



> Touch the icon «Personal memory».



> Touch the icon «Save stitch pattern».
> Select the file where the stitch pattern to be overwritten has been saved.
> Select the stitch pattern which should be overwritten.



> Touch the icon «Confirm».

Loading stitch patterns from the personal memory

Prerequisite:

- The stitch pattern is saved in the personal memory.



> Touch the icon «Personal memory».



> Touch the icon «Stitch pattern selection».
> Select the file where the stitch pattern has been saved.
> Select a stitch pattern.

Deleting stitch patterns from the personal memory

Prerequisite:

- The stitch pattern is saved in the personal memory.



> Touch the icon «Personal memory».



> Touch the icon «Delete».
> Select the file where the stitch pattern has been saved.
> Select a stitch pattern.



> Touch the icon «Confirm» to delete the stitch pattern.

Uploading a stitch pattern from the BERNINA USB stick



> Touch the icon «Personal memory».



> Touch the icon «Load embroidery motif».
> Touch the icon (1).

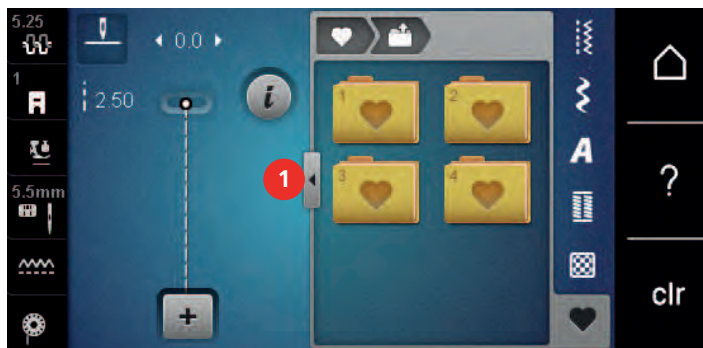

> Insert the BERNINA USB stick into the USB port of the machine.
> Touch the icon «USB stick».
> Select the desired stitch pattern.

Deleting stitch patterns from the BERNINA USB stick



> Touch the icon «Personal memory».



> Touch the icon «Delete».
> Insert the BERNINA USB stick into the USB port of the machine.
> Select the stitch pattern which is to be deleted.



> Touch the icon «Confirm».

5.7 Securing

Securing a seam with the button «Securing»

The button «Securing» can be programmed with various securing stitches.



> Push the button «Securing» before starting to sew.
– The stitch pattern/stitch pattern combination will be secured with the number of programmed stitches when sewing is started.
> Press the button «Securing» while sewing.
– The machine stops immediately and secures with the number of programmed stitches.

Securing via the icon «Securing»

Every single pattern of a stitch pattern combination can be secured either at the beginning or at the end.



> Touch the icon «i»-Dialog.



> Touch the icon «Securing» before starting to sew.
– The stitch pattern/stitch pattern combination is secured with 4 stitches at the beginning.

- > Touch the icon «Securing» while sewing.
 - The stitch pattern or the active stitch pattern of the stitch pattern combination is secured with 4 stitches at the end.

5.8 Height Compensation of uneven layers

If the presser foot is at an angle when sewing over a thick seam, the feed dog cannot grip the fabric and the sewing project cannot be sewn out properly.

- > Place 1 – 3 compensating plates as required from the back of the presser foot close to the needle to level the fabric layer.

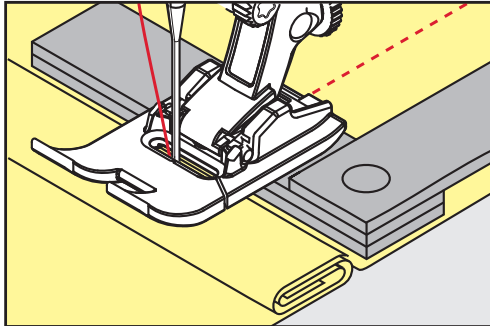

- The presser foot is leveled with the sewing project.

- > Place 1 – 3 compensating plates as required from the front of the presser foot close to the needle to level the fabric layer.

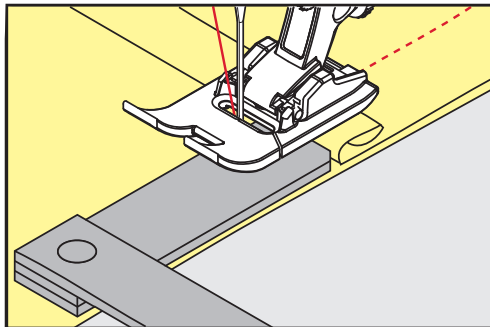

- The presser foot is leveled with the sewing project.

- > Sew until the complete presser foot has passed the thick seam.
- > Remove the plates of the height compensation.

5.9 Sewing Corners

When sewing corners, only a small section of the fabric is actually on the feed dog. Therefore it cannot grip the fabric well. By means of the height compensation tool the fabric can be fed evenly.

- > When the fabric edge is reached, stop the sewing process with needle position down.
- > Raise the presser foot.
- > Turn the fabric and place in desired position.
- > Place 1 – 3 compensating plates as required on the right of the presser foot close to the sewing project.
- > Lower the presser foot.

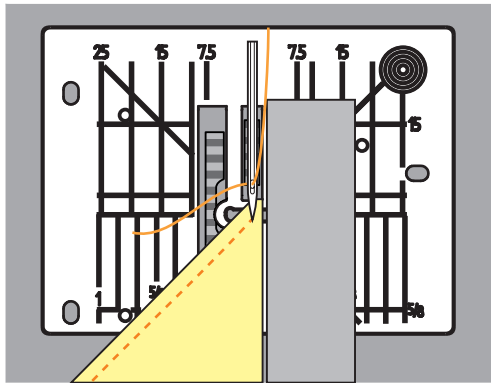







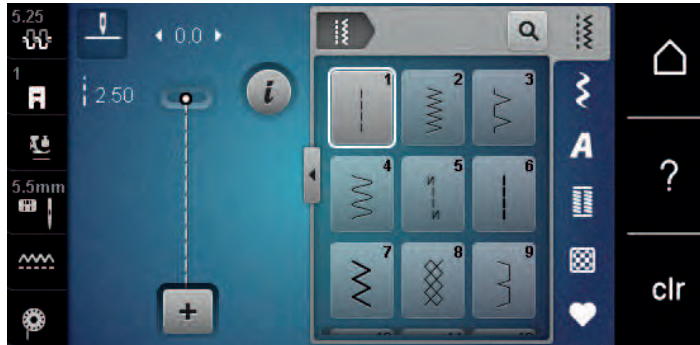





- > Resume sewing until the sewing project is on the feed dog again.

6 Practical stitches

6.1 Overview Practical stitches



Stitch patterns	Stitch number	Name	Description
	1	Straight stitch	Seams and topstitching.
	2	Zig zag	Reinforcing seams, finishing edges, sewing elastic seams and attaching lace.
	3	Vari overlock	Sewing and finishing elastic fabrics in one step.
	4	Running stitch	Darning with running stitch, mending fabrics, reinforcing edges.
	5	Securing Program	Securing starts and ends of seams by straight stitching.
	6	Triple Straight stitch	For durable seams in firm fabrics, visible hems and seams.
	7	Triple Zig zag	For durable seams in firm fabrics, visible hems and seams.
	8	Honeycomb stitch	For elastic fabrics and hems. Is also used with elastic bobbin threads.
	9	Blindstitch	Blind hems, shell edging effect on soft jerseys and fine material, decorative seams.
	10	Double overlock	Sewing and finishing elastic fabrics in one step.
	11	Superstretch stitch	For highly stretch fabrics. For all types of clothing.

Stitch patterns	Stitch number	Name	Description
	12	Gathering stitch	Most types of fabric; gathering with shirring elastic, butted seams = butting two pressed edges and sewing together, decorative stitches.
	13	Stretch overlock	Sewing and finishing elastic fabrics in one step.
	14	Tricot stitch	Visible hems, visible seams in lingerie, sweaters, mending jersey.
	15	Universal stitch	For firm fabrics such as felt and leather. Flat joining seams, visible seams, attaching elastic, decorative seams.
	16	Sewn-out Zig zag	Edge finishing and reinforcing, attaching elastic, decorative seam.
	17	Lycra stitch	For lycra fabrics; flat joining seams and hems, reinforced seaming on underwear.
	18	Stretch stitch	For highly stretch fabrics; open seam for sportswear.
	19	Reinforced overlock	For medium-weight knitware and toweling; overlock seams, flat joining seams.
	20	Knit overlock	Sewing and finishing in one step of hand and machine knitted fabrics.
	22	Simple Darning Program	Darning of holes and damaged fabric.
	23	Reinforced Darning Program	Reinforcing darning holes and damaged fabric.
	24	Bartack Program	Reinforcing pocket openings, sewing belt loops.
	25	Bartack Program	Reinforcing pocket openings, sewing on belt loops, securing zippers and seam ends.
	26	Large Fly stitch	Reinforcing pocket openings, zippers and slits in medium-weight to thick fabrics.
	29	Blindstitch narrow	For blind hems in fine fabrics.
	30	Basting stitch	For bastings seams, hems, quilts, etc.

Stitch patterns	Stitch number	Name	Description
	32	Single Straight stitch	Used as a connecting stitch in a combination.
	33	Three single straight stitches	As connecting stitches in a combination.
XXXX	34	Darning stitch	For darning.

6.2 Sewing straight stitch

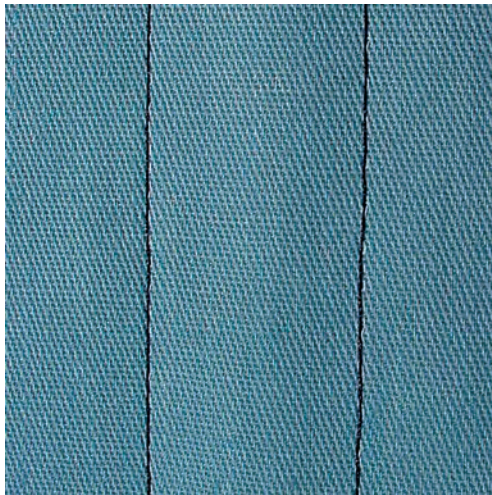

Match the stitch length with the sewing project, which means for denim fabrics long stitches (ca. 3 – 4 mm), for fine fabrics short stitches (ca. 2 – 2.5 mm). Match the stitch length with the thread size, e.g. long stitches when topstitching with Cordonnet (ca. 3 – 5 mm).

The straight stitch, also called step stitch, is the most used stitch.

Prerequisite:

- The Reverse pattern foot No. 1 is attached.
- > Touch the icon «Practical stitches».
 - The Straight stitch No. 1 is selected automatically.



6.3 Securing with the automatic Securing Program

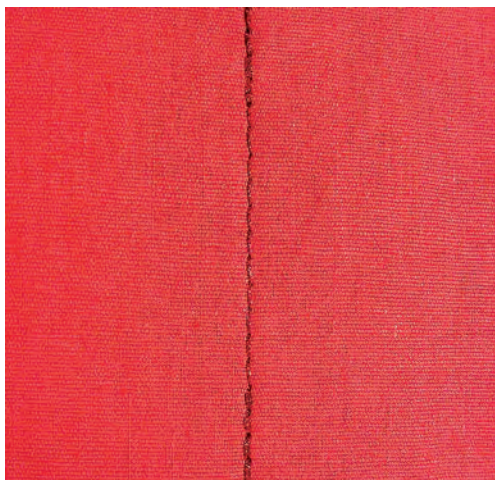

Due to a defined number of sewn stitches, 5 stitches forward and 5 stitches in reverse, securing is done evenly.

Prerequisite:

- The Reverse pattern foot No.1 is attached.



- > Touch the icon «Practical stitches».
- > Select the Securing Program No. 5.
- > Press the foot control.
 - The machine secures automatically.

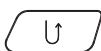

- > Sew the seam in the desired length.
- > Push the button «Quick reverse».
 - The machine secures automatically and stops at the end of the securing program.

6.4 Sewing in the zipper

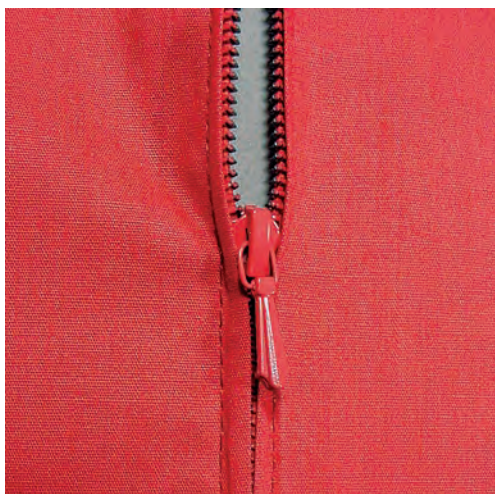

As the fabric feed can be difficult when starting to sew, it is recommended to hold the threads firmly or to pull the fabric slightly to the back for a few stitches or to sew 1 – 2 cm reverse first.

- > Attach the Reverse pattern foot No. 1.



- > Touch the icon «Practical stitches».
 - The Straight stitch No. 1 is selected automatically.
- > Sew the seam up to where the zipper starts.
- > Sew the securing stitches.
- > Close the zipper length with long stitches.
- > Finish the seam allowances.
- > Iron the seam.
- > Open the zipper length.
- > Baste the zipper under the fabric so that the fabric folded edges meet over the center of the zipper.
- > Open the zipper a few centimeters.
- > Attach the Zipper foot No. 4.
- > Move the needle position to the right.
- > Use the Free Hand System to raise the presser foot and to position the sewing project.
- > Start sewing from top left.
- > Guide the foot so that the needle stitches along the zipper coils.
- > Stop in front of the zipper pull with needle position down.
- > Raise the presser foot.
- > Close the zipper.
- > Continue to sew and stop in front of the base of the zipper with needle position down.
- > Raise the presser foot and turn the sewing project.
- > Sew across the other side of the zipper and stop with needle position down.
- > Raise the presser foot and turn the sewing project.
- > Sew the second side from bottom to top.

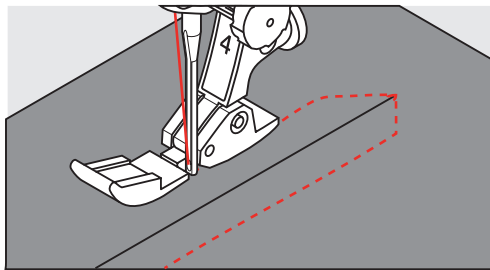

6.5 Sewing both sides of the zipper from bottom to top

It is recommended to sew in the zipper on both sides from bottom to top. This alternative is suitable for all the fabric with nap such as velvet.



When the fabric is densely woven or hard, it is recommended to use a needle with the size 90 – 100. This results in an even stitch formation.



- > Attach the Reverse pattern foot No. 1.
- > Touch the icon «Practical stitches».
 - The Straight stitch No. 1 is selected automatically.
- > Sew the seam up to where the zipper starts.
- > Sew the securing stitches.
- > Close the zipper length with long stitches.
- > Finish the seam allowances.
- > Iron the seam.
- > Open the zipper length.
- > Baste the zipper under the fabric so that the fabric folded edges meet over the center of the zipper.
- > Attach the Zipper foot No. 4.
- > Move the needle position to the right.

- > Use the Free Hand System to raise the presser foot and to position the sewing project.
- > Start sewing in the center of the seam at the end of the zipper.
- > Sew diagonally along the edge of the zipper coils.
- > Sew the first side (1) from bottom to top.
- > Stop in front of the zipper pull with needle position down.
- > Raise the presser foot.
- > Open the zipper as far as behind the presser foot.
- > Lower the presser foot and continue sewing.
- > Sew the second side (2) in exactly the same way from bottom to top.

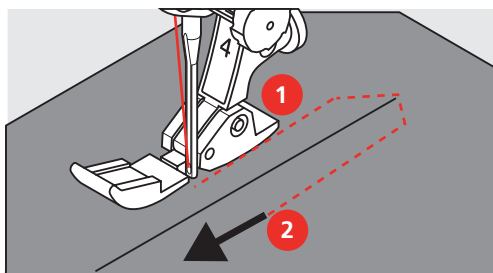

6.6 Sewing triple straight stitch



The triple straight stitch is especially suitable for durable seams and for firm, densely woven fabrics such as denim and corduroy. For firm or densely woven materials it is recommended to attach the Jeans foot No. 8. This will help to sew denim or canvas. For decorative topstitching, the stitch length can be elongated.

- > Attach the Reverse pattern foot No. 1.
- > Touch the icon «Practical stitches».
- > Select the Triple straight stitch No. 6.



6.7 Sewing Triple zig zag

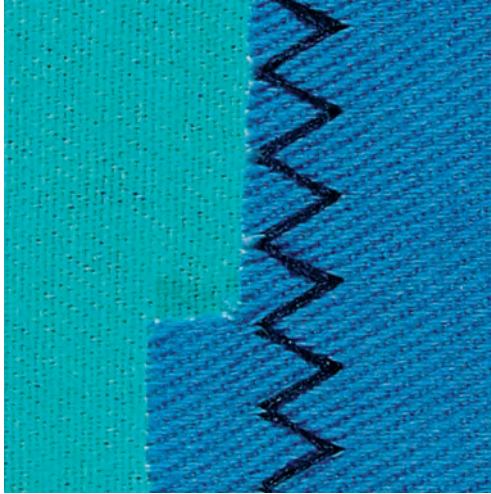

For firm fabrics, especially for denim, deckchair covers, awnings. Hems on items that need frequent washing. Finish the hem edges first.

- > Attach the Reverse pattern foot No. 1.
- > Touch the icon «Practical stitches».
- > Select the Triple zig zag No. 7.



6.8 Manual darning

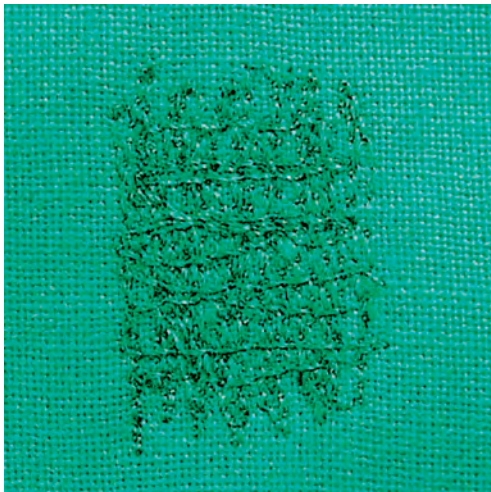

Used for darning holes or worn areas in all fabric types.

If the thread is lying on top and a poor stitch formation results, slow down the movement of the sewing project. If there are knots on the wrong side of the fabric, move the sewing project faster. When the thread breaks, guide the sewing project more consistently.

- > Attach the Darning foot No. 9 (optional accessory).
- > Touch the icon «Practical stitches».
 - The Straight stitch No. 1 is selected automatically.
- > Lower the feed dog.
- > Attach the slide-on table.
- > Hoop the sewing project in the round embroidery hoop (optional accessory).
 - The darning area stays evenly taut and cannot be distorted.



- > Sew from the left to the right, guide the fabric evenly by hand without using pressure.
- > Move in curves when changing the direction to avoid holes and thread breakage.
- > Work the rows in irregular lengths so that the thread is better spread over the fabric.

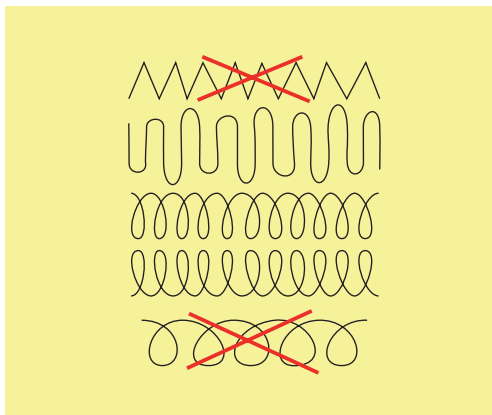

- > Sew the first rows not too close together and beyond the worn area.
- > Sew the rows in irregular lengths.

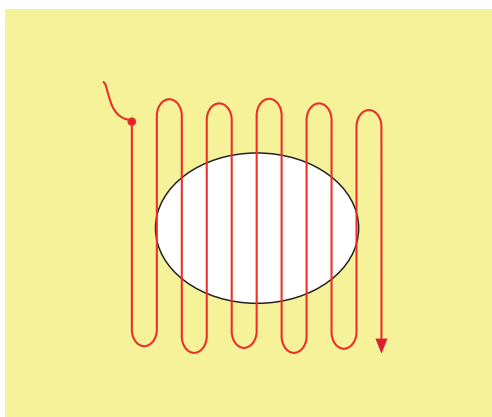

- > Turn the sewing project by 90°.
- > Sew the first rows not too close.

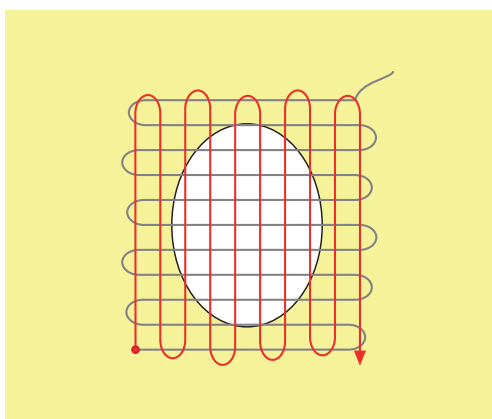

- > Turn the sewing project by 180°.

- > Sew another loose row.

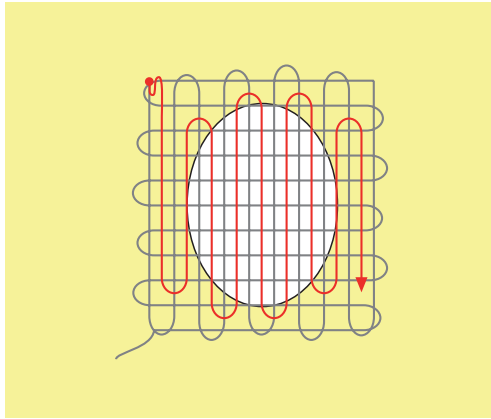

6.9 Automatic darning

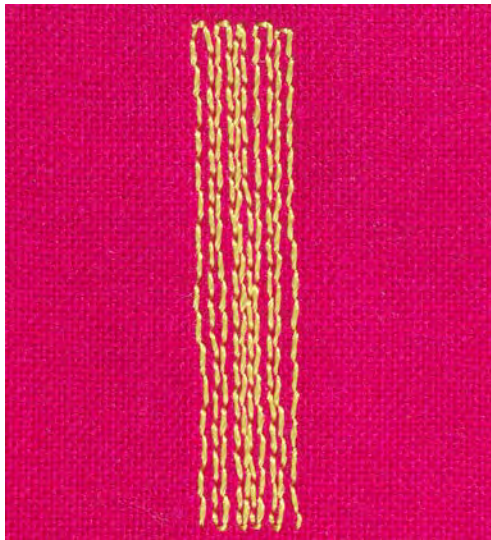

The simple Darning Program No. 22 is especially suitable for quick darning of worn or damaged areas or snags. It is recommended to use fine material as a backing for the worn and damaged areas or to stick an adhesive interlining. The simple Darning Program No. 22 replaces threads along the lengthwise grain in all materials. If the darned area becomes distorted, correct with the balance.

- > Attach the Reverse pattern foot No. 1 or the Buttonhole foot No. 3A.
- > Touch the icon «Practical stitches».
- > Select the simple Darning Program No. 22.
- > Hoop light-weight materials in the round embroidery hoop (optional accessory).
 - The area to be darned stays evenly taut and cannot be distorted.
- > Start sewing top left.
- > Sew the first row.
- > Stop the machine.
- > Push the button «Quick reverse».
 - The length is programmed.
- > Finish sewing the Darning Program.
 - The machine stops automatically.

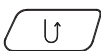

6.10 Reinforced darning, automatic



The reinforced Darning Program No. 23 is especially suitable for quick darning of worn or damaged areas. The reinforced Darning Program No. 23 replaces threads along the lengthwise grain in all materials.



If the Darning Program does not cover the whole worn or damaged area, it is recommended to reposition the work and to sew the Darning Program again. The length is programmed and can be repeated as often as desired.

Via the direct entry length, a darning length up to 30 mm can be programmed.



- > Attach the Buttonhole foot No. 3A.
- > Touch the icon «Practical stitches».
- > Select the reinforced Darning Program No. 23.
- > Hoop light-weight materials in the round embroidery hoop (optional accessory).
 - The darning area stays evenly taut and cannot be distorted.

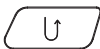

- > Start sewing top left.
- > Sew the first row.
- > Stop the machine.
- > Push the button «Quick reverse».
 - The length is programmed.
- > Finish sewing the Darning Program.
 - The machine stops automatically.

6.11 Reinforced Darning Program

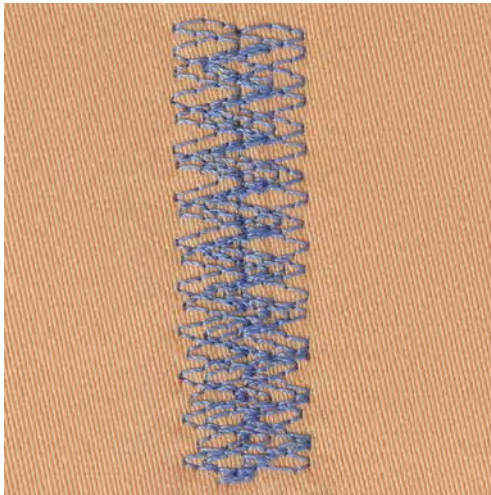

The Darning Program No. 34 is especially suitable for darning worn or damaged areas in heavy or firm fabrics, such as jeans or working clothes.

- > Attach the Reverse pattern foot No. 1.
- > Touch the icon «Practical stitches».
- > Select the Darning Program No. 34.



6.12 Finishing edges



The Zig zag No. 2 is suitable for all materials. It can also be used for elastic seams as well as for decorative sewing. Use darning thread for fine materials. When sewing satin stitch, it is recommended to select a dense, short the zig zag with a stitch length of 0.5 – 0.7 mm. The satin stitch can be used for appliqué and for embroidering.

Prerequisite:

- The edge of the fabric should lie flat and not roll.
- > Attach the Reverse pattern foot No. 1.
- > Touch the icon «Practical stitches».
- > Select the Zig zag No. 2 or the Satin stitch No. 1315.
- > Neither select too wide a stitch nor too long a stitch.



- > Guide the edge of the fabric into the center of the presser foot, so that the needle goes into the fabric on one side and over the edge into the air on the other side.

6.13 Sewing Double overlock

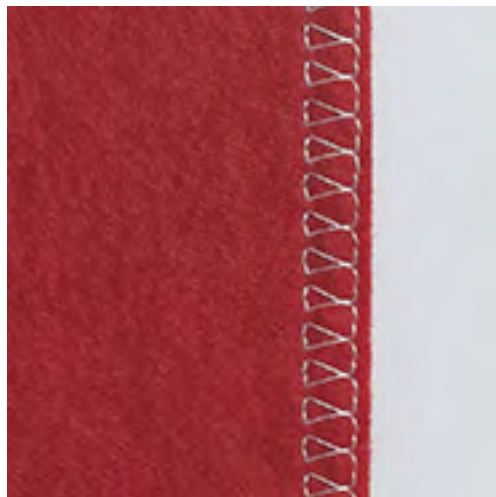

A double overlock seam is suitable for loose knitware and cross seams in knits. When working with knitware, a new jersey needle should be used to prevent damaging the delicate stitches. When sewing elastic materials, use a stretch needle.

- > Attach the Reverse pattern foot No. 1 or the Overlock foot No. 2.
- > Touch the icon «Practical stitches».
- > Select the Double overlock No. 10.



6.14 Narrow edgestitching

- > Attach the Blindstitch foot No. 5 (optional accessory) or the Reverse pattern foot No. 1 or the Edge stitch foot No. 10 (optional accessory).
- > Touch the icon «Practical stitches».
 - The Straight stitch No. 1 is selected automatically.
- > Place the edge on the left against the guide on the Blindstitch foot.
- > Select the needle position left at the desired distance to the edge.

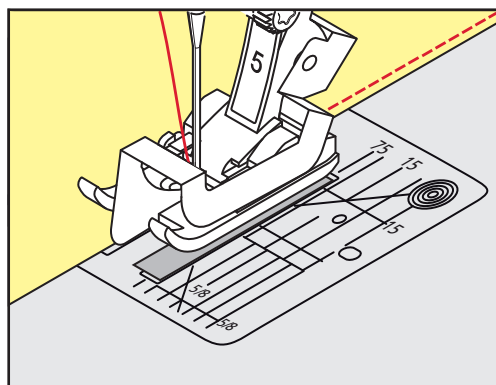

6.15 Wide edgestitching

- > Attach the Blindstitch foot No. 5 (optional accessory) or the Reverse pattern foot No. 1 or the Edge stitch foot No. 10 (optional accessory).



- > Touch the icon «Practical stitches».
 - The Straight stitch No. 1 is selected automatically.
- > Guide the edge along the presser foot or at a distance of 1 – 2.5 cm (0.39 – 0.98 inch) along the marks.
- > Select the needle position at the desired distance to the edge.

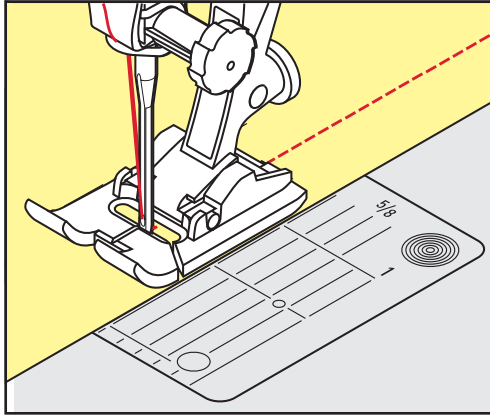

6.16 Edgestitching using the seam guide (optional accessory)

When sewing parallel wider lines, it is recommended to guide the seam guide (optional accessory) along a sewn line.



- > Attach the Reverse pattern foot No. 1 or the Edge stitch foot No. 10 (optional accessory).
- > Touch the icon «Practical stitches».
 - The Straight stitch No. 1 is selected automatically.
- > Loosen the screw on the back of the presser foot.
- > Insert the seam guide into the hole of the presser foot.
- > Adjust the width as desired.
- > Tighten the screw.
- > Guide the folded edge along the seam guide.

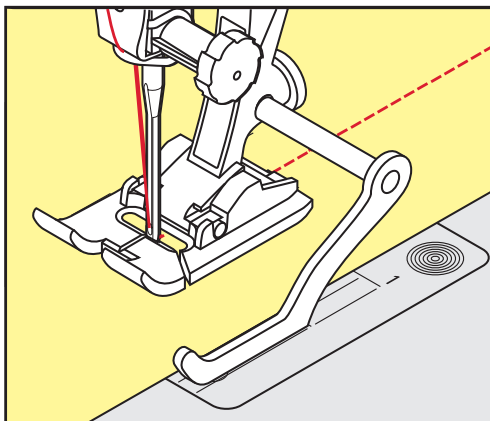

6.17 Sewing hem edges

When using the Blindstitch foot No. 5 (optional accessory), it is recommended to select a needle position far left or far right. When using the Reverse pattern foot No. 1 or the Edge stitch foot No. 10 all needle positions are possible.

- > Attach the Blindstitch foot No. 5 (optional accessory) or the Reverse pattern foot No. 1 or the Edge stitch foot No. 10 (optional accessory).



- > Touch the icon «Practical stitches».
 - The Straight stitch No. 1 is selected automatically.
- > Place the inside upper edge right against the guide of the Blindstitch foot.
- > Select the needle position far right to sew along the upper edge.

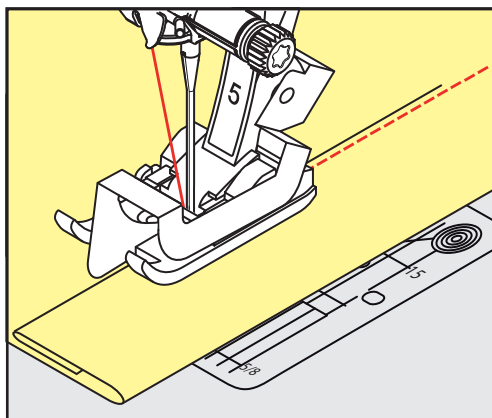

6.18 Sewing blind hems

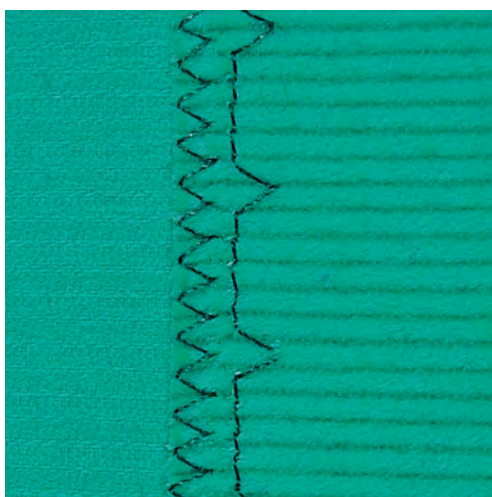

For invisible hems in medium to heavy-weight cotton, wool and blended materials.

Prerequisite:

- The fabric edges are finished.
- > Attach the Blindstitch foot No. 5 (optional accessory).



- > Touch the icon «Practical stitches».
- > Select the Blindstitch No. 9.
- > Fold the fabric back over the right side of the fabric to expose the finished lower edge.
- > Place the fabric under the presser foot and move the folded edge against the metal guide on the presser foot.
- > Guide the folded edge evenly along the metal guide of the foot to sew the stitches evenly deep.
 - Make sure that the needle only pierces the edge of the fold.

- > After sewing about 10 cm (ca. 3.93 inch) check both sides of the fabric and adjust the width again if necessary.

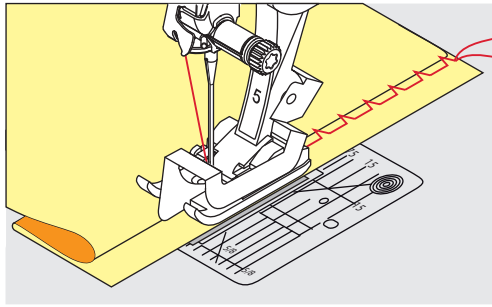

6.19 Sewing visible hems



The visible hem is especially suitable for elastic hems in jersey, cotton, wool, synthetic and mixed fibers.

- > Attach the Reverse pattern foot No. 1.
- > Touch the icon «Practical stitches».
- > Select Tricot stitch No. 14.
- > Iron the hem and baste if necessary.
- > Reduce the presser foot pressure if necessary.
- > Sew the hem at the preferred depth on the right side.
- > Trim the excess fabric from the wrong side.



6.20 Sewing flat joining seams

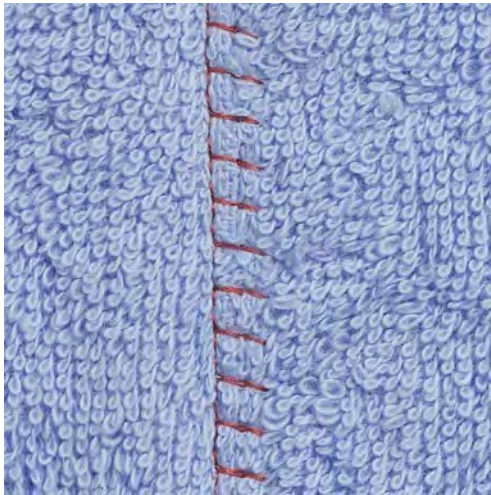

The flat joining seam is especially suitable for long-pile or thick materials such as terry cloth, felt or leather.

- > Attach the Reverse pattern foot No. 1.
- > Touch the icon «Practical stitches».
- > Select the Stretch overlock No. 13.
- > Overlap the fabric edges.
- > Sew along the fabric edge.
- > The needle must stitch over the edge of the top layer on the right into the bottom layer to get a very flat durable seam.



6.21 Sewing basting stitches

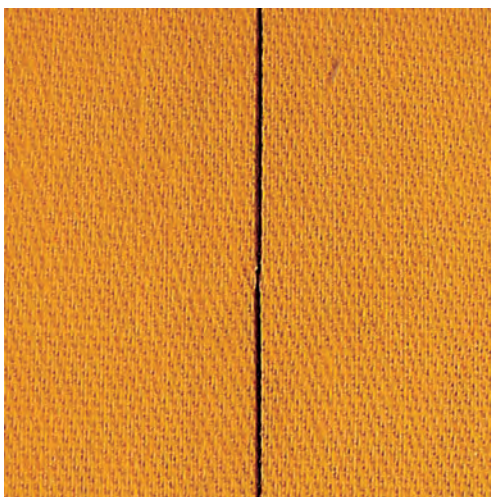

For basting it is recommended to use a thin darning thread as it can be removed easily. The basting stitch is suitable for work where a large stitch length is desired.

- > Attach the Darning foot No. 9 (optional accessory).
- > Lower the feed dog.
- > Touch the icon «Practical stitches».
- > Select the Basting stitch No. 30.
- > Pin the fabric layers at a right angle to basting direction to prevent the layers from slipping.
- > Hold the threads and sew 3 - 4 securing stitches at the beginning.
- > Sew a stitch and pull the fabric back at the desired stitch length.
- > Sew a stitch.
- > At the end sew 3 - 4 securing stitches.



7 Decorative stitches

7.1 Overview Decorative Stitches

Depending on the type of material, simple or more complex decorative stitches should be selected to best suit the material.

- Decorative stitches which are programmed with simple straight stitches are particularly appropriate for light-weight materials, e.g. the Decorative stitch No. 101.
- Decorative stitches which are programmed with triple straight stitches or with a few satin stitches are particularly appropriate for medium-weight materials, e.g. Decorative stitch No. 107.
- Decorative stitches which are programmed with satin stitches are particularly appropriate for heavy-weight materials, e.g. Decorative stitch No. 401.

For a perfect stitch formation, it is of advantage to use the same thread color for upper and bobbin thread and a stabilizer. With pile or long-fiber materials it is recommended to use an additional, water-soluble stabilizer on the right side which can be easily removed after sewing.



Decorative stitch	Category	Name
	Category 100	Natural stitches
	Category 300	Cross stitches
	Category 400	Satin stitches
	Category 600	Ornamental stitches
	Category 700	Heirloom stitches
	Category 900	Children stitches

7.2 Bobbin-Play

NOTICE

Inappropriate bobbin case is used

Damage of the bobbin case.

- > Use the Bobbinwork bobbin (optional accessory).



The bobbin can be filled with different thread material. For free-motion stitching to add texture. This method is similar like free-motion sewing, but is done on the **wrong** side of the fabric.

Reinforce the area to be sewn with embroidery stabilizer. The design can be drawn on the wrong side of the fabric. You can also draw the design on the front side of the fabric. The lines can be followed with a freely guided straight stitch using polyester, cotton or rayon thread. The rows of stitching are visible on the wrong side of the fabric, and serve as reference lines for the bobbin-thread sewing.

Bobbin-thread sewing can be done using the BSR function. It is recommended to guide your project at consistent speed evenly under the needle, following the lines of the design. The stabilizer must be removed after sewing.

First sew a sample to check what the result looks like on the wrong side of the fabric.

Not all decorative stitches are suitable for this technique. Using simple decorative stitches provide the best results. Avoid compact stitch types and beads of buttonholes.

- > Attach the Embroidery foot No. 20.
- > Touch the icon «Decorative stitches».
- > Select an appropriate decorative stitch.
- > Turn the «Upper Multifunctional knob» and the «Lower Multifunctional knob» to adjust the stitch length and the stitch width so that a nice stitch formation can be achieved even when using thick thread.
- > Touch the icon «Upper thread tension» and adjust the upper thread tension if necessary.



7.3 Sewing cross stitches

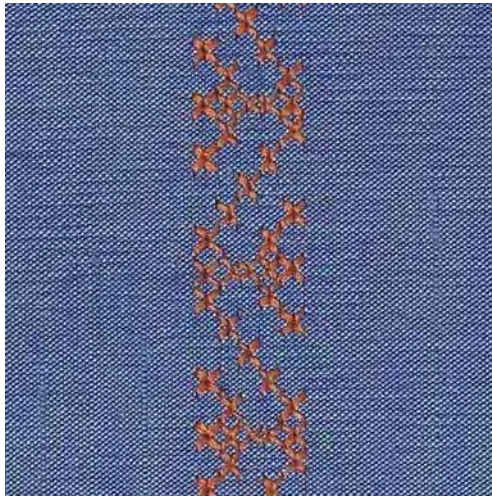

Cross stitch embroidery is a traditional technique and a charming addition to the other decorative stitches. If the cross stitches are sewn on a fabric with a linen texture, they look like hand-stitched cross stitching. When cross stitches are sewn with embroidery yarn, the stitch pattern appears fuller. Cross stitches are particularly used for home furnishing, trimmings on garments and embellishing in general. As every following line refers to the first row, it is important to stitch the first row in a straight line.

- > Attach the Reverse pattern foot No. 1 or the Open Embroidery foot No. 20.
- > Select a cross stitch of the Categorie 300 and combine it as desired.
- > Stitch the first row using the seam guide or slide-on table seam guide to sew a straight line.
- > Stitch the second row next to the first at a distance of one presser foot's width or using the seam guide.





7.4 Pintucks

Pintucks

This technique reduces the size of the fabric which means that always enough fabric should be calculated. Pintucks are narrow stitched folds which are normally sewn on the fabric before cutting out the pieces for garments or other sewing projects. They are suitable for embellishing or in combination with other heirloom embroidery techniques.

A more distinctive and relief-like effect can be achieved when the pintucks are corded, which means that they are sewn with an additional pintuck cord. Choose a pintuck cord that fits well into the grooves of the selected pintuck foot. The cord must be colorfast and shrink-proof.

Overview pintucks

Pintuck foot	Number	Description
	30 (optional accessory) 3 grooves	4 mm double needle: for heavy fabrics.
	31 (optional accessory) 5 grooves	3 mm double needle: for heavy to medium-weight fabrics.
	32 (optional accessory) 7 grooves	2 mm double needle: for light to medium-weight fabrics.
	33 (optional accessory) 9 grooves	1 or 1.6 mm double needle: for very light fabrics (without pintuck cord).

Inserting the cord

- > Switch the machine off and disconnect it from the power supply system.
- > Remove the needle.
- > Remove the presser foot.
- > Remove the stitch plate.
- > Open the bobbin cover.
- > Pull the cord through the hook opening from the bottom and through the opening of the stitch plate.
- > Replace the stitch plate.
- > Close the bobbin cover.
- > Make sure that the cord slides through the little thread slot of the bobbin cover.

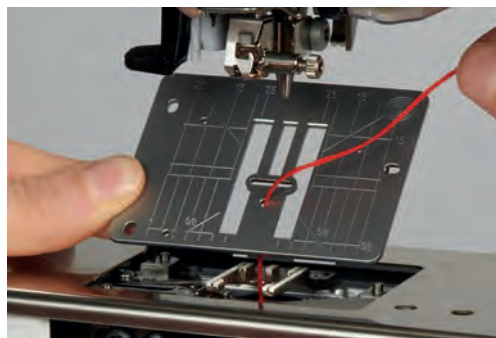

- > Place the cord spool on the knee lifter.

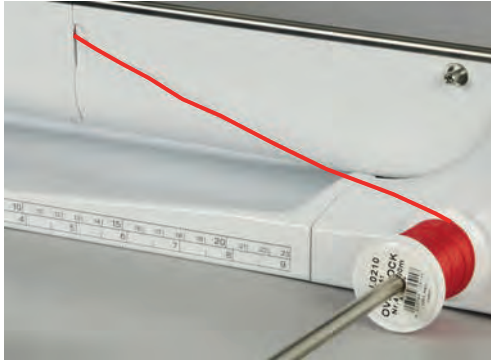

- > Check that the cord runs smoothly.
- > If the thread doesn't glide smoothly at the bobbin cover, leave the bobbin cover open.

Sewing Pintucks

The cord lies on the wrong side of the material and is held/sewn over by the bobbin thread.

- > Sewing the first pintuck.
- > Place the first pintuck in one of the side grooves in the presser foot.
- > Sew additional pintucks parallel.

8 Alphabets

8.1 Overview Alphabet

Block, Double block, Script and Comic alphabets as well as as Cyrillic can be sewn in two different sizes. Monograms can be sewn in three different sizes. Block, Double block, Script and Comic alphabets as well as as Cyrillic can also be sewn in lower case letters.

For a perfect stitch formation, use the same thread color for upper and bobbin threads. The fabric can be reinforced with embroidery stabilizer on the wrong side. When working with pile or napped fabrics, e.g. toweling, use an additional, water-soluble stabilizer on the right side of the fabric.

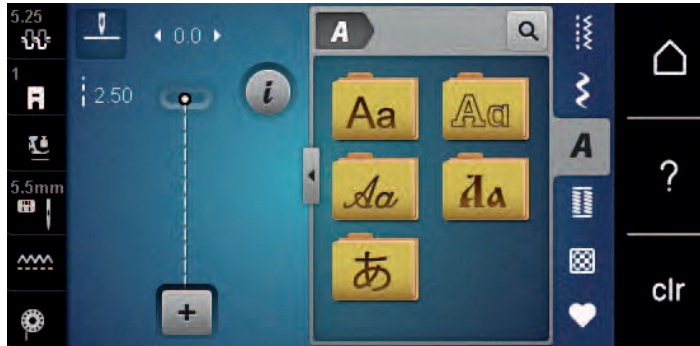

Stitch patterns	Name
ABCabc	Block alphabet
ABCabc	Double-Block
<i>ABCabc</i>	Script (Italics)
АБВабв	Cyrillic
あいう	Hiragana

8.2 Creating lettering



It is recommend to sew a test sample using the desired thread, the original fabric and the original stabilizer. Please make sure that the fabric is fed evenly and lightly without colloding and being caught. Do not pull, push or hold the fabric while sewing.



- > Touch the icon «Alphabets».
- > Select the font.



- > Touch the icon «Single/Combi mode» to create a combination.

- > Touch the icon «Display alphabets» (1) to open an extended enter mode.



- > Select the letters.
- > Touch the icon (2) (standard setting) to use upper case letters.
- > Touch the icon (3) to use lower case letters.
- > Touch the icon (4) to use figures.
- > Touch the icon (5) to use special characters and mathematical symbols.

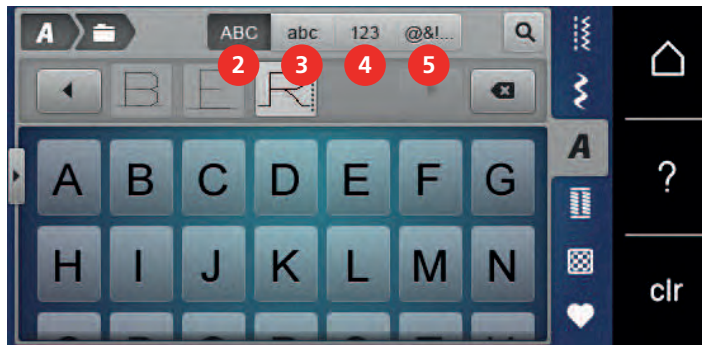

- > Touch the icon «DEL» to delete single letters of the entered text.
- > Touch the icon «Display alphabets» again to close the extended enter mode.







9 Buttonholes

9.1 Overview Buttonholes

To create the correct buttonhole for every button, every purpose and for every garment, your BERNINA 535 is equipped with a considerable collection of buttonholes. The corresponding button can be sewn on automatically. Eyelets can also be sewn.



Buttonhole	Buttonhole number	Name	Description
	51	Standard buttonhole	For light to medium-weight fabrics; blouses, dresses, bedlinens.
	52	Standard buttonhole narrow	For light to medium-weight fabrics; blouses, dresses, children's and baby clothes, crafts.
	53	Stretch buttonhole	For any highly elastic jersey made from cotton, wool, silk and synthetic fibers.
	54	Round buttonhole with normal bartack	For medium to heavy-weight fabrics: dresses, jackets, coats, rainwear.
	55	Round Buttonhole with horizontal bartack	For medium to heavy-weight fabrics: dresses, jackets, coats, rainwear.
	56	Keyhole buttonhole	For heavy-weight, non-stretch fabrics; jackets, coats, leisure wear.
	57	Keyhole buttonhole with pointed bartack	For firm, non-stretch fabrics: jackets, coats, leisure wear.
	59	Straight stitch buttonhole	Program for staystitching buttonholes, for pocket openings, reinforcing buttonholes, especially for buttonholes in leather and imitation leather.
	63	Heirloom	For light to medium-weight woven fabrics; blouses, dresses, leisure wear, bedlinens.

Buttonhole	Buttonhole number	Name	Description
	60	Button sew-on program	For buttons with 2 and 4 holes.
	61	Eyelet with small zig zag	Openings for cords and narrow ribbons, for decorative work.
	62	Straight-stitch eyelet	Openings for cords and narrow ribbons, for decorative work.
	64	Double-rounded buttonhole	For medium to heavy-weight fabrics made of various material.
	66	Buttonhole with double pointed bartack, narrow	Decorative buttonhole for medium-weight fabrics; blouses, dresses, jackets.
	69	Decorative buttonhole with double pointed bartack	For decorative buttonholes in firmer, non-elastic fabrics.

9.2 Making use of the height compensation tool

When a buttonhole is to be sewn at right angles to the project edge, it is recommend to use the height compensation plates (optional accessory).

- > Place the plates from the back between the sewing project and the bottom of the slide to the thick part of the sewing project.

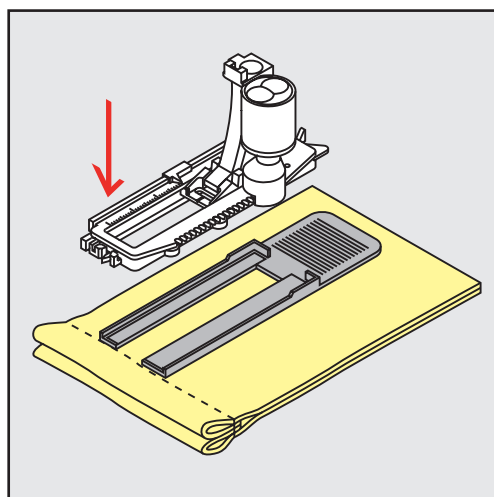

- > Lower the presser foot.

9.3 Using the compensation plate

When sewing a buttonhole in difficult materials, it is recommended to use the compensation plate for buttonholes (optional accessory). It can be used along with the Buttonhole foot No. 3A.

- > Insert the compensation plate carefully from the side.

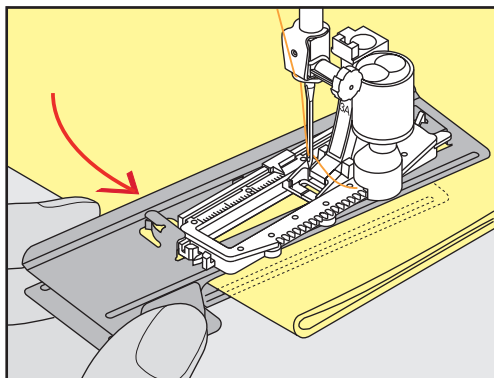

9.4 Marking buttonholes

- > For the buttonholes to be sewn manually, mark the position and the length on the fabric using chalk or a water-soluble pen.

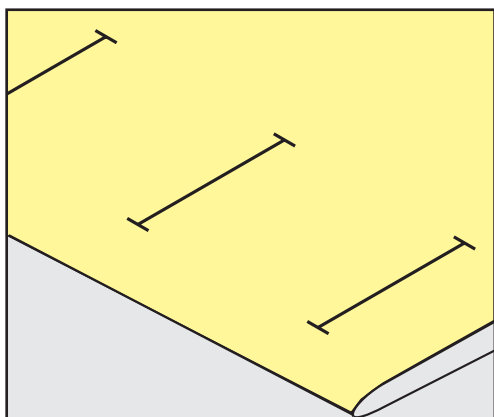

- > For the buttonholes to be sewn automatically, mark the complete length of 1 buttonhole on the fabric using chalk or a water-soluble pen. For any subsequent buttonholes mark the starting point.

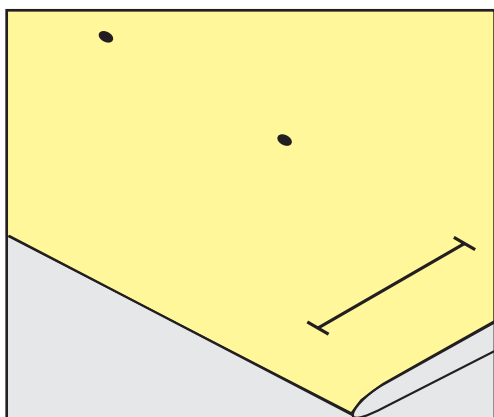

- > For keyhole and round buttonholes mark the length of the bead with chalk or a water-soluble pen on the fabric. For any subsequent buttonholes mark the starting point. The length of the keyhole is sewn additionally.

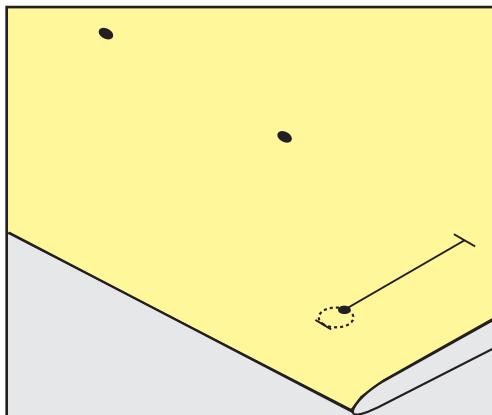

9.5 Cord

Using cord with the Buttonhole foot with slide No. 3A

The cord reinforces and enhances the buttonhole and is particularly suitable for the Buttonhole No. 51. Optimal cord is Perle cotton No. 8, strong hand-sewing thread and fine crochet yarn. It is recommended not to hold the cord when sewing.

Prerequisite:

- The Buttonhole foot with slide No. 3A is attached and raised.
- > Insert the needle at the beginning of the buttonhole.
- > Guide the cord on the right side under the buttonhole foot.
- > Hook the cord over the pin at the back of the buttonhole foot.

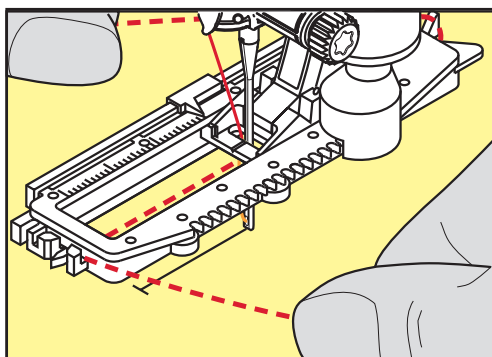

- > Pull the cord on the left side under the buttonhole foot to the front.

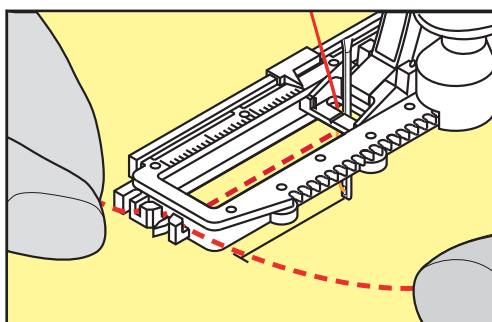

- > Pull the cord ends into the slits.
- > Lower the buttonhole foot.
- > Sew the buttonhole in the usual manner.
- > Pull the cord through the buttonhole until the loop disappears in the bartack.
- > Pull the ends of the cord through to the wrong side of the fabric (using a hand stitching-needle), knot or secure with stitches.

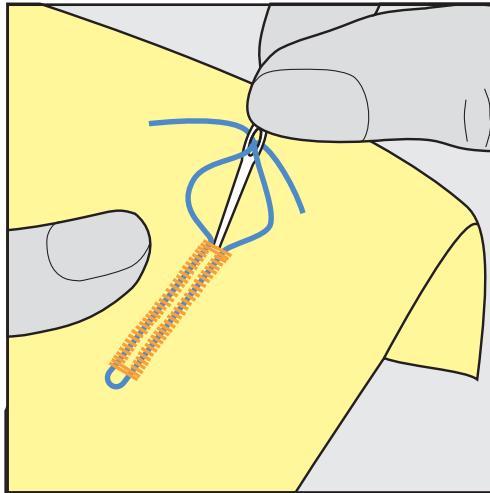

Using cord with the Buttonhole foot with slide No. 3 (optional accessory)

Prerequisite:

- The Buttonhole foot with slide No. 3 (optional accessory) is attached and raised.
- > Insert the needle at the beginning of the buttonhole.
- > Guide the cord on the right side under the buttonhole foot.

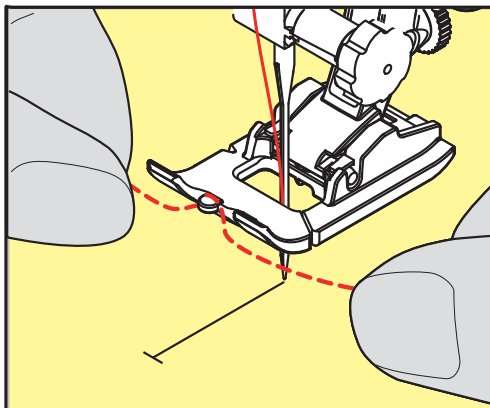

- > Pull both cord ends under the buttonhole foot to the back and insert each a cord into the slits of the sole.

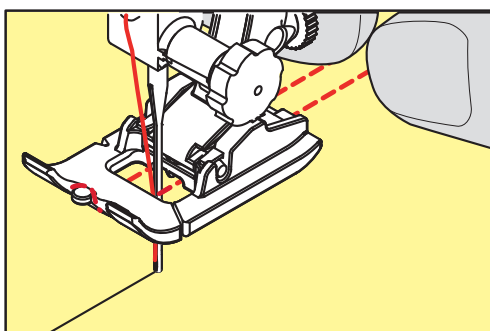

- > Lower the buttonhole foot.
- > Sew the buttonhole in the usual manner.
- > Pull the cord through the buttonhole until the loop disappears in the bartack.
- > Pull the ends of the cord through to the wrong side of the fabric (using a hand stitching-needle), knot or secure with stitches.

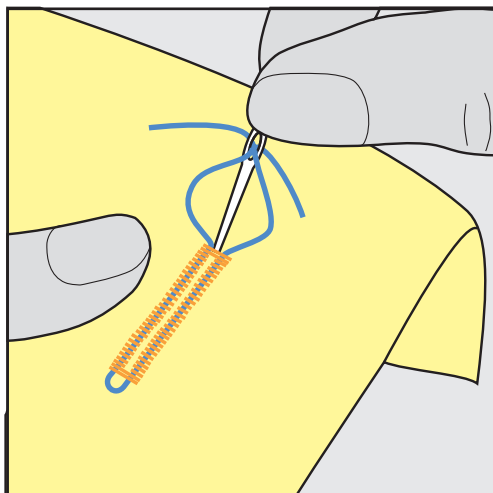

9.6 Sewing a test sample

Always sew a test sample of the buttonhole on the same fabric: It is recommended to use the same stabilizer and to select the same buttonhole. The test sample should also be sewn in the respective direction. By sewing a test sample the settings can be adjusted until the sewing result is satisfying.

When working with soft loosely woven materials or for buttonholes which are highly stressed, it is worth underlaying the buttonholes with the Straight stitch buttonhole No. 59. This is also recommended to reinforce buttonholes in leather, vinyl or felt.

Alterations of the balance when sewing a manual standard buttonhole as well as the keyhole and the round buttonhole affect both beads in the same way. With the manual keyhole or round buttonhole the alterations affect both sides differently.

If the stitch counter function is used and alterations are made concerning the balance, the alterations affect both buttonhole beads differently.



- > Touch the icon «Buttonholes».
- > Select the buttonhole.
- > Select and attach the desired presser foot.
- > Place the fabric under the presser foot and lower the presser foot.
- > Press the foot control carefully and start sewing. Guide the fabric slightly.
- > Check the balance while sewing and adjust if necessary.
- > Check the test sample and make further amendments if necessary.

9.7 Determining the buttonhole slit width

The width of the buttonhole slit can be adjusted between 0.1 – 2.0 mm before sewing.



- > Touch the icon «Buttonholes».
- > Select the buttonhole.



- > Touch the icon «i»-Dialog.

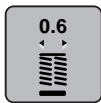

- > Touch the icon «Buttonhole slit width».
- > Turn the «Upper Multifunctional knob» or the «Lower Multifunctional knob» to adjust the buttonhole slit width as desired.

9.8 Determining the buttonhole length



The button can be centered in the yellow circle on the display. By means of the «Multifunctional knobs up/down» the yellow circle can be enlarged or downsized to determine the diameter of the button.

Additionally to the diameter of the button, 2 mm are added automatically for the buttonhole length. If the diameter of the button is 14 mm, the buttonhole length is calculated 16 mm.

Prerequisite:

- The Buttonhole foot with slide No. 3A is attached.



- > Touch the icon «Buttonholes».
- > Select the buttonhole.



- > Touch the icon «i»-Dialog.

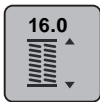

- > Touch the icon «Adjust the buttonhole length».
- > Turn the «Upper Multifunctional knob» or the «Lower Multifunctional knob» to adjust the buttonhole length.

9.9 Using the stitch counter function

The stitch counter function is suitable for all types of buttonholes. The left buttonhole bead is sewn forward, the right buttonhole bead is sewn in reverse. If alterations of the balance are made, the stitch counter function should be saved for every buttonhole separately.

Prerequisite:

- The Buttonhole foot No. 3 (optional accessory) is attached.



- > Touch the icon «Buttonholes».
- > Select the buttonhole.



- > Touch the icon «i»-Dialog.



- > Touch the icon «Program the length with the stitch counter».
- > Sew the desired buttonhole length.
- > Stop the machine.

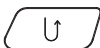

- > Push the button «Quick reverse» so that the machine sews the lower bartack and the second bead in reverse.
- > Stop the machine at the height of the first stitch.
- > Push the button «Quick reverse» again so that the machine sews the upper bartack and the securing stitches.
 - The length of the buttonhole remains saved and every subsequent buttonhole is sewn identically until the machine is switched off.

9.10 Sewing a buttonhole automatically

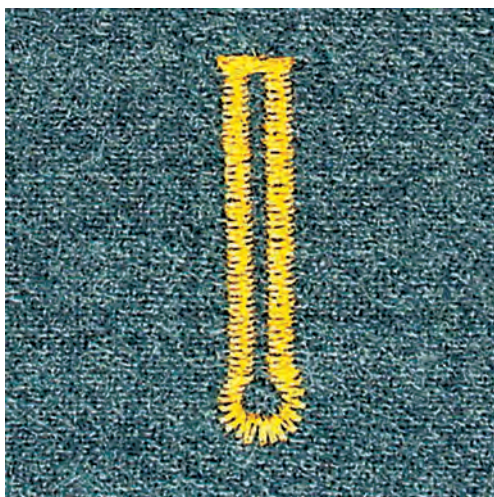
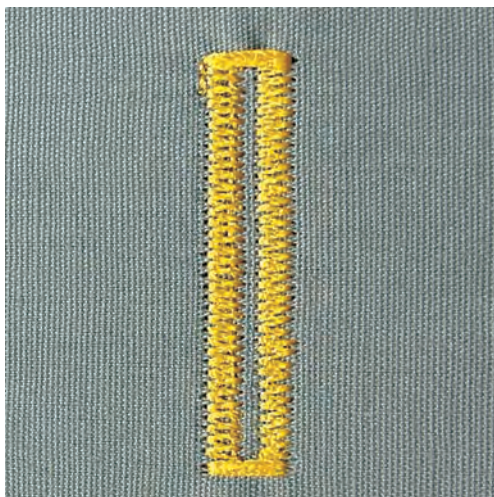

When the Buttonhole foot with slide No. 3A is used, the length of the buttonhole is measured automatically by the lens on the presser foot. The buttonhole will be duplicated and the machine switches to the next step automatically when the maximum length is reached. The Buttonhole foot with slide No. 3A is suitable for buttonholes in the length of 4 – 31 mm, depending on the buttonhole type. The slide of the Buttonhole foot must lie perfectly flat on the fabric so that the length can be measured accurately. All the programmed buttonholes are the same length and of the same nice look.

Prerequisite:

- The Buttonhole foot with slide No. 3A is attached.



- > Touch the icon «Buttonholes».
- > Select the Buttonhole No. 51 – 59, No. 63, 64, 66 or 69.
- > Sew the desired buttonhole length.

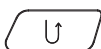

- > Push the button «Quick reverse» to program the length.



- > Push the button «Start/Stop» or the foot control.
 - The machine finishes the buttonhole automatically. All subsequent buttonholes are sewn at the same length.

9.11 Programming the Heirloom buttonhole

Prerequisite:

- The Buttonhole foot with slide No. 3A is attached.



- > Touch the icon «Buttonholes».
- > Select the Buttonhole No. 63.
- > Sew the desired buttonhole length.

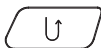

- > Push the button «Quick reverse» to program the length.
 - The machine finishes the buttonhole automatically. All subsequent buttonholes are sewn at the same length.

9.12 Sewing the manual 7-step buttonhole

The length of the buttonhole is determined manually when sewing. Bartack, eye and securing stitches are preprogrammed. The individual steps can also be selected by scrolling using the arrow icons or by touching the button «Quick Reverse».

Prerequisite:

- The Buttonhole foot No. 3 (optional accessory) is attached.



- > Touch the icon «Buttonholes».
- > Select the Buttonhole No. 51.



- > Touch the icon «i»-Dialog.



- > Touch the icon «Adjust the length manually».
 - Step 1 in the display is activated for the buttonhole start.
- > Sew the desired buttonhole length.
 - As soon as sewing is started, step 2 is activated.

- > Stop the machine at desired length of the buttonhole or at the end of the length marking.



- > Touch the icon «Scroll down» so that step 3 appears.
 - The machine sews straight stitches in reverse.
- > Stop the machine at the height of the first stitch where the buttonhole starts.
- > Touch the icon «Scroll down» so that step 4 appears.
 - The machine sews the upper bartack and stops automatically.
- > Touch the icon «Scroll down» so that step 5 appears.
 - The machine sews the second bead.
- > Stop the machine at the height of the last stitch of the first bead.
- > Touch the icon «Scroll down» so that step 6 appears.
 - The machine sews the lower bartack and stops automatically.

- > Touch the icon «Scroll down» so that step 7 appears.



- The machine secures and stops automatically.

9.13 Sewing the manual 5-step buttonhole

The length of the buttonhole is determined manually when sewing. Bartack, eye and securing stitches are preprogrammed. The individual steps can also be selected by scrolling using the arrow icons or by touching the button «Quick Reverse».

Prerequisite:

- The Buttonhole foot No. 3 (optional accessory) is attached.



- > Touch the icon «Buttonholes».
- > Select the Buttonhole No. 54.



- > Touch the icon «i»-Dialog.



- > Touch the icon «Adjust the length manually».
- Step 1 the display is activated for the buttonhole start.

- > Sew the desired buttonhole length.
- Step 2 is activated.

- > Stop sewing at the desired length of the bead or at the marking.



- > Touch the icon «Scroll down» so that step 3 appears.
- > The machine sews the eye or the keyhole and stops automatically.
- > Touch the icon «Scroll down» so that step 4 appears.
- The machine sews the second bead in reverse.
- > Stop the machine at the first stitch where the buttonhole starts.
- > Touch the icon «Scroll down» so that step 5 appears.



- The machine sews the upper bartack and secures automatically.

9.14 Cutting the buttonhole open with the seam ripper

- > Place a pin in each end of the buttonhole to avoid accidental cutting into ends of buttonhole.
- > Cut the buttonhole from both ends to the middle.

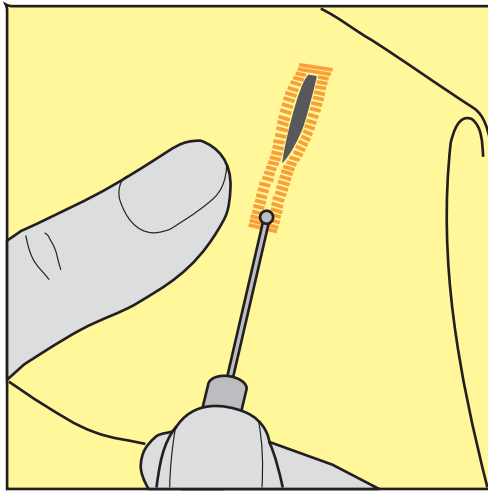

9.15 Cutting open buttonholes with the buttonhole cutter (optional accessory)

- > Place the fabric on an appropriate piece of wood.

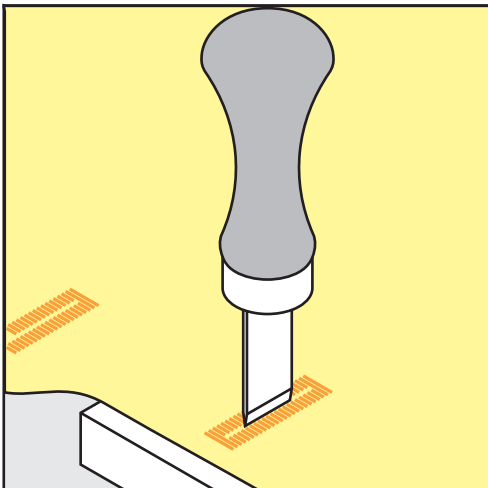

- > Position the cutter in the center of the buttonhole.
- > Press down on the cutter with your hand.

9.16 Sewing on buttons

With the Button sew-on Program buttons with 2 or 4 holes can be sewn on. To reinforce the stability the Button sew-on Program can be sewn twice. When sewing on a button with 4 holes, the front holes should be sewn first.

Buttons sewn on for decorative purposes only are stitched without a thread shank. The shank height is the distance between the button and the fabric. When using the Button sew-on foot No. 18 (optional accessory), the shank height can be adjusted with the screw.

With the Button sew-on Program the first securing stitch is always stitched into the left hole of the button.

Prerequisite:

- The Darning foot No. 9 (optional accessory) or the Button sew-on foot No. 18 (optional accessory) is attached.



- > Touch the icon «Buttonholes».
- > Lower the feed dog.
- > Select the Button sew-on Program No. 60.
- > Place the button on the sewing project.
- > Turn the handwheel to adjust the distance between the holes.
- > Hold the threads when starting to sew and, if necessary, alter the stitch width.
 - The machine sews the Button sew-on Program and stops automatically.
- > Pull on both bobbin threads until the ends of the upper threads are visible on the wrong side.
- > Knot the ends manually.

9.17 Sewing eyelets



For increased stability sew the eyelet twice.

Prerequisite:

- The Reverse pattern foot No. 1 or the Open embroidery foot No. 20 is attached.



- > Touch the icon «Buttonholes».
- > Select the Eyelet Program No. 61 or No. 62.
- > Turn the «Upper Multifunctional knob» or the «Lower Multifunctional knob» to alter the size of the eyelet.
- > Sew the Eyelet Program.
 - The machine stops automatically at the end of the Eyelet Program.
- > Use an awl, punch pliers or a hole punch to open the eyelet.

10 Quilting

10.1 Overview Quilt Stitches

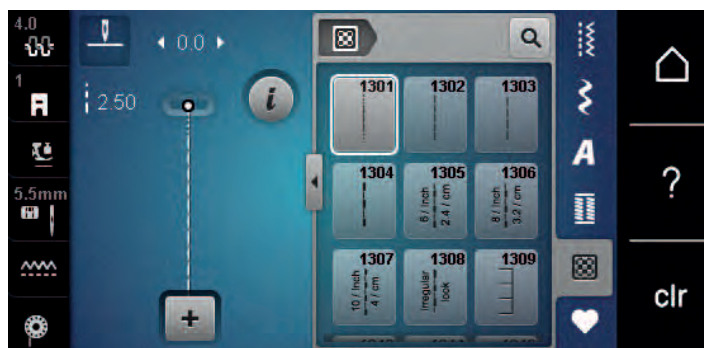

Stitch patterns	Stitch number	Name	Description
⋮	1301	Quilting, Securing Program	To secure at the sewing start and sewing end with short stitches forward.
⋮	1302	Quilting straight stitch	Straight stitch at 3 mm stitch length.
⋮	1303	Piecing stitch/Straight stitch	Straight stitch at 2 mm stitch length.
⋮	1304	Handlook quilt stitch 1304 – 1308	Imitation of handlook quilt stitch with monofilament.
⋮	1309	Blanket stitch 1309 – 1310	For appliqué and sewing on ribbons.
⋮	1311	Decorative Quilt stitches 1311, 1313 – 1314, 1317 – 1327, 1329 – 1330, 1339 – 1346	Imitation of handlook quilt stitch with monofilament.
⋮	1315	Satin stitch	For appliqué.
⋮	1316	Blindstitch narrow	To sew blind stitches.
⋮	1331	Stippling stitch	Imitation of stipple quilting.
⋮	1332	Feather stitch	For "Crazy Patchwork" and embellishing.
⋮	1333	Feather stitch variations 1333 – 1338	For "Crazy Patchwork" and embellishing.

10.2 Quilting, Securing Program

Prerequisite:

- The Reverse pattern foot No.1 is attached.



- > Touch the icon «Quilt stitches».
- > Select Quilt stitch pattern No. 1301.
- > Press the foot control.
 - The machine sews 6 stitches forward automatically when sewing is started.

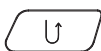

- > Sew the seam in the desired length.
- > Push the button «Quick reverse».
 - The machine sews 6 stitches forward automatically and stops automatically at the end of the Securing Program.

10.3 Sewing handlook quilt stitches

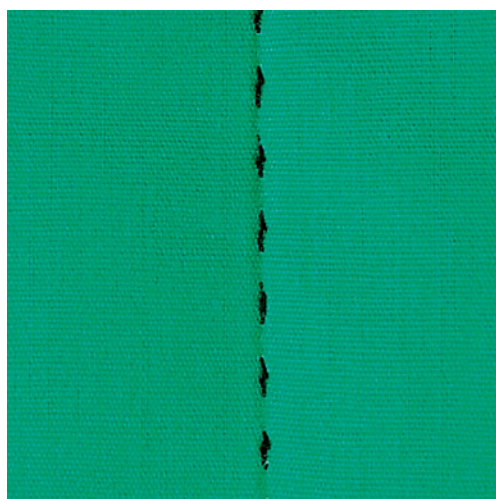

Handlook quilt stitches are suitable for all fabrics and sewing projects which should look «hand sewn». It is recommended to use a monofilament thread as upper thread and an embroidery thread as bobbin thread. The sewing speed should be moderate to prevent the monofilament from breaking. If required, the upper thread tension and the balance can be adjusted to the sewing project and the desired quilt stitch.

Prerequisite:

- The Reverse pattern foot No. 1 is attached.



- > Touch the icon «Quilt stitches».
- > Select the Handlook quilt stitch No. 1304 - 1308.
- > Bei If required, adjust the upper thread tension and the balance to the sewing project and the desired quilt stitch.
- > Press the foot control or the button «Start/Stop» to start the machine.

10.4 Guiding the quilt work freely



Quilt gloves with rubber fingertips (optional accessory) will help when guiding the fabric.

It is recommended to use the slide-on table and the Free Hand System. With free-motion quilting, it is of advantage to quilt from the center outwards and to guide the fabric using smooth, round movements to form the design of your choice. Free-motion quilting and darning are based on the same free-motion principles.

With stipple quilting, entire surfaces of the fabric are filled with quilt stitches. The single lines of stitching are rounded and never cross one another.

Prerequisite:

- The top layer, the batting and the backing are pinned together or basted.
- The feed dog is lowered.
- The Darning foot No. 9 (optional accessory) is attached.



- > Touch the icon «Practical stitches».
 - The Straight stitch No. 1 is selected automatically.
- > Adjust the upper thread tension and the balance to the sewing project if necessary.
- > Press the foot control or the button «Start/Stop» to start the machine.
- > Hold both hands close to the presser foot like an embroidery hoop to guide the fabric.
- > If the thread is lying on top of the fabric, slow down the movement.
- > If there are knots on the wrong side of the fabric, move the fabric more quickly.

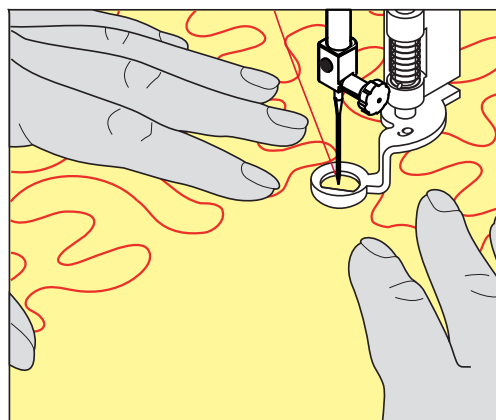

11 BERNINA Stitch Regulator (BSR)

The BERNINA Stitch regulator equalizes the stitch length which results of the free movement of the fabric while free-motion sewing - a sewing technique which grows more and more popular. When free-motion sewing with the BSR presser foot, every stitch is equally long and the stitch formation is perfectly regular.

As soon as the BSR presser foot is attached and the feed dog is lowered, the selection menu of the desired mode appears in the display of the machine. The BSR presser foot can be used with sewing straight stitch as well as zig zag.

The BSR presser foot reacts on the movement of the fabric and therefore controls the speed of the machine up to the highest possible speed. It can be said: The faster the movement of the material, the higher the speed of the machine.

If the fabric is moved too quickly, an acoustic signal sounds. The beeper can be activated or deactivated in the «BSR» display. The sound of the beeper can also be activated or deactivated in the Setup Program.

11.1 BSR mode 1

The BSR function can be controlled via the foot control or with the button «Start/Stop». Start the BSR mode. At the BSR presser foot a red light is on. By moving the fabric the machine accelerates. If the fabric isn't moved, securing in place is possible without pressing an additional button. When working via the foot control or when using the button «Start/Stop», the BSR mode doesn't stop automatically.

11.2 BSR mode 2

The BSR function can be controlled via the foot control or the button «Start/Stop». The machine starts only when the foot control or the button «Start/Stop» is pressed and the fabric is moved simultaneously. Without moving the fabric, the BSR2 modus stops after about 7 seconds. The red light goes off (only when working with the button «Start/Stop»). When working via the foot control, the red light doesn't go off.

11.3 BSR function with Straight stitch No. 1

This function allows free-motion quilting with straight stitch and a pre-programmed stitch length up to 4 mm. The programmed stitch length is maintained within a certain speed, independent of the fabric movement.

11.4 BSR function with Zig zag No. 2

The zig zag can be used e.g. for thread painting. The set stitch length will **not** be maintained when sewing the zig zag stitch, but the BSR function simplifies the application.

11.5 Sewing preparations for quilting

Attach the BSR presser foot

NOTICE

The lens of the BSR presser foot is dirty

The machine doesn't recognize the BSR presser foot.

> Clean the lens with a soft, slightly damp cloth.

> Change the presser foot.

- > Insert the cable of the BSR foot into the connection (1). The BSR plug must be inserted vertically.



- > Switch the machine on.
 - The BSR display opens and the BSR 1 mode is activated.

Changing the presser foot sole

NOTICE

The lens of the BSR presser foot is dirty.

The machine doesn't recognize the BSR presser foot.

- > Clean the lens with a soft, slightly damp cloth.

The basic stitch length is 2 mm. When sewing small shapes and stippling, it is recommended to shorten the stitch length to 1 – 1.5 mm.

- > Raise the needle.
- > Raise the BSR foot.
- > Switch the machine off and disconnect it from the power supply system.
- > Remove the BSR foot from the machine.
- > Press both push buttons at the BSR foot against each other.

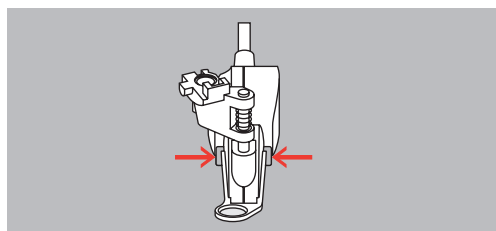

- > Pull the presser foot sole out of the guide downwards.
- > Insert the new presser foot sole into the guide and push upwards until it clicks into place.
- > Attach the BSR presser foot.

11.6 Using the BSR mode

The BSR function can be controlled via the foot control or the button «Start/Stop».

Starting via the foot control: The foot control needs to be pressed while quilting. The machine keeps running in the BSR1 mode until the foot control is released, even if the fabric isn't moved.

If quilting is stopped in the BSR2 mode, the machine sews another stitch depending on the needle position and stops with needle position up.

Prerequisite:

- The slide-on table is attached.
- The knee lifter of the Free Hand System is attached.

- > Lower the feed dog.
- > Select the desired BSR mode.
- > Lower the presser foot.



- > Push the button «Start/Stop» or press the foot control and keep it pressed to start the BSR mode.
 - At the BSR foot a red light is on.



- > Move the fabric to control the speed of the machine in the BSR mode.
- > Push the button «Start/Stop» again or release the foot control to stop the BSR mode.
 - The BSR mode stops and the red light at the presser foot goes off.

- > Touch the icon «BSR» (1) to deactivate the BSR mode and to quilt without automatic stitch length.



11.7 Securing

Securing in BSR1 mode with the button «Start/Stop»

Prerequisite:

- The BSR presser foot is attached and connected with the machine.
- The BSR display is opened and the BSR1 mode is activated.

- > Lower the feed dog.
- > Lower the presser foot.
- > Push the button «Needle up/down» twice.
 - The bobbin thread is brought up.



- > Hold the upper and the bobbin thread.



- > Push the button «Start/Stop».
 - Start the BSR mode.

- > Sew 5 – 6 securing stitches.



- > Push the button «Start/Stop».
 - The BSR mode stops.

- > Cut the thread.

Securing in BSR2 mode

Prerequisite:

- The BSR presser foot is attached and connected with the machine.
- The BSR display is open and the BSR2 mode is activated.

- > Lower the presser foot.
- > Touch the icon «i»-Dialog.



- > Touch the icon «Securing».



- > Push the button «Start/Stop».
- > Press the foot control or the button «Start/Stop».



By moving the fabric some short securing stitches are sewn, then the programmed stitch length is activated and the securing function is deactivated automatically.

12 My BERNINA Embroidery

12.1 Overview Embroidery module



- | | | | |
|---|---|---|-----------------------------|
| 1 | Release lever/carrying handle | 4 | Guide rails for the machine |
| 2 | Embroidery arm | 5 | Connection to the machine |
| 3 | Bracket for attaching the embroidery hoop | | |

12.2 Supplied accessories Embroidery module

Overview Accessories Embroidery module







Illustration	Name	Purpose
	Embroidery foot No. 26	For embroidering, darning and free-motion quilting.
	Embroidery hoop oval, 145 x 255 mm (5.70 x 10.03 inch) with embroidery template, VAR 00	To embroider large embroidery motifs. The embroidery template serves the purpose to calibrate the embroidery hoop and to place the fabric exactly.

Illustration	Name	Purpose
	Embroidery hoop medium, 100 x 130 mm (3.39 x 5.11 inch) with embroidery template	To embroider medium-sized embroidery motifs. The embroidery template serves the purpose to calibrate the embroidery hoop and to place the fabric exactly.
	USB Connecting cable	The USB connecting cable serves the purpose to transfer data. When the embroidery software (optional accessory) is installed on the computer, embroidery motifs can be transferred from the computer to the machine.
	Embroidery needle assortment SUK	Various needle sizes for embroidering.
	Template holder	The template holders serve as a help when placing and removing the template in and from the embroidery hoop.
	Net for thread spool, white	The spool net provides an even unwinding of the thread when using slippery embroidery threads.

12.3 Overview User Interface

Overview functions/visual information



- | | | | |
|---|---|---|---|
| 1 | Upper thread tension | 4 | Stitch plate/Needle selection |
| 2 | Presser foot display/Presser foot selection | 5 | Feed dog up/down |
| 3 | Embroidery hoop selection/Embroidery hoop display | 6 | Instruction how to thread the bobbin thread display |

Overview System settings

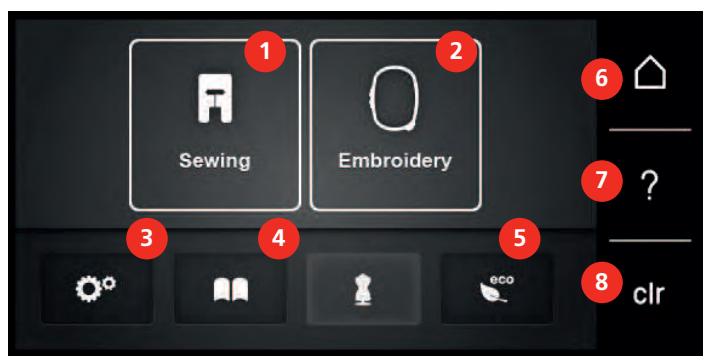

- | | | | |
|---|-----------------|---|-------------------------|
| 1 | Sewing mode | 5 | eco-Modus |
| 2 | Embroidery mode | 6 | Home |
| 3 | Setup Program | 7 | Help |
| 4 | Tutorial | 8 | Back to default setting |

Overview Selection menu embroidery

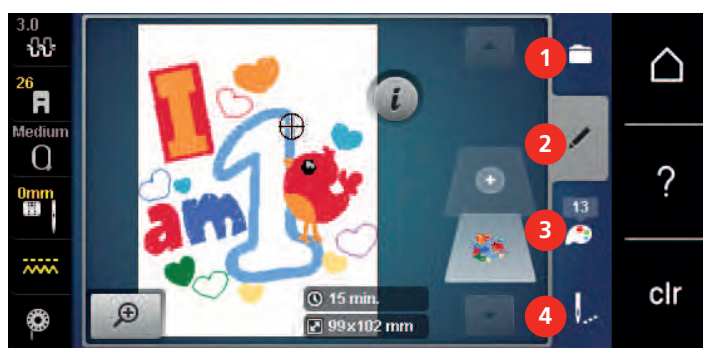

- | | | | |
|---|-----------------------------|---|-------------------|
| 1 | Selection embroidery motifs | 3 | Color information |
| 2 | Editing embroidery motifs | 4 | Embroidery |

12.4 Important Embroidery information

Upper thread

A good quality thread (brand manufacturer) is essential for embroidery so that the embroidery is not affected negatively because of poor thread or thread breakage.

Embroidery is particularly effective if you use 40wt glossy rayon or polyester embroidery threads as upper threads. They are available in a wide range of colors for beautiful embroidery.

- Glossy polyester with a brilliant sheen is a hard wearing, colorfast thread and has a high tensile strength which is suitable for all types of embroidery.
- Rayon is a soft viscose fiber with a brilliant sheen and suitable for fine, delicate embroidery, or items that will not receive excessive wear and tear.
- Metallic thread is a light to medium-weight thread suitable for special effects in embroidery.
- When working with metallic threads, the automatic bobbin thread cutter should be deactivated. The other thread cutters shouldn't be used either because the knives are likely to wear off very quickly.

- When using metallic threads, the speed and the upper thread tension should be reduced.



Bobbin thread

In most cases black or white bobbin thread is used for embroidering. When both sides should have the same look, it is recommended to use the same color for bobbin and upper thread.

- Bobbin Fill is an especially soft and light polyester thread which is suited well to be used as bobbin thread. This special bobbin thread ensures a steady thread tension and an optimal intertwining of the upper and bobbin thread.
- Darning and embroidery threads are fine mercerized cotton threads which are suitable for embroidery on cotton.



Selecting the embroidery file format

In order that embroidery motifs can be read by the BERNINA embroidery machine, they have to be created by the BERNINA Embroidery software and exported as .EXP file. Besides the actual embroidery file, a .BMP file and an .INF file are generated additionally. The .BMP file allows a preview of the embroidery motif and the

.INF file provides the information on the thread colors. **Please note:** If the .INF file is missing, the embroidery motif cannot be displayed in the real color but only in standard colors. In this case, the colors can be entered manually in the color overview of the motif on the machine.

Additionally, following embroidery formats can be read by the machine: .PES, .PEC, .XXX, .PCS, .JEF and .DST. BERNINA International AG doesn't warrant that embroidery motifs which have not been created or converted by the BERNINA Embroidery software can be correctly read and embroidered.

Simple motifs with a low stitch count are suitable for embroidery on fine material. Densely embroidered motifs, e. g. embroidered motifs with multiple color and embroidery direction changes, are suitable for medium and heavy-weight material.

Embroidery test

For the embroidery test, always use the original material reinforced with the same stabilizer as will be used later. For the embroidery test it is recommended to use the same colors, threads and needles which are planned to be used for the embroidery project.

The size of the embroidery motif

Embroidery motifs can be enlarged or downsized on the embroidery machine or on the PC using the BERNINA Embroidery software (optional accessory). Enlargements or reductions up to 20% achieve the best results.

Embroidering motifs by third-party providers

BERNINA recommends to upload embroidery motifs of any file format via the free program «ART-Link» to the machine or a USB stick. Using «ART-Link» ensures that the embroidery motif can be read and embroidered correctly. «ART-Link» can be downloaded for free at www.bernina.com.

Underlay stitches

Underlay stitches are the foundation of a motif and are used to stabilize the base material and hold it in shape. They also prevent the covering stitches of the motif from sinking into the knit or the nap of the material.

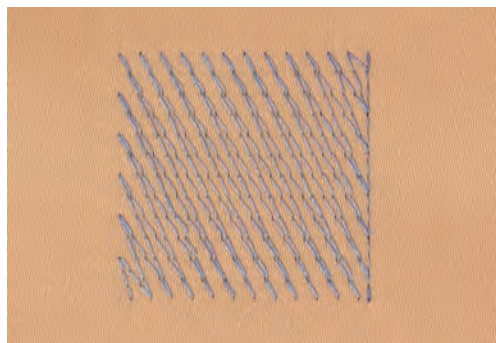

Satin stitch

The needle moves left to right and vice versa. The result is a very dense, covering zig zag stitching to fill the shape. Satin stitching fills are ideal for narrow and small shapes. Satin stitching is, however, not suitable for larger areas, since wide stitches are too loose and do not cover the fabric properly. In addition there is the risk that with too long stitches the threads could catch on something which would damage the embroidery.

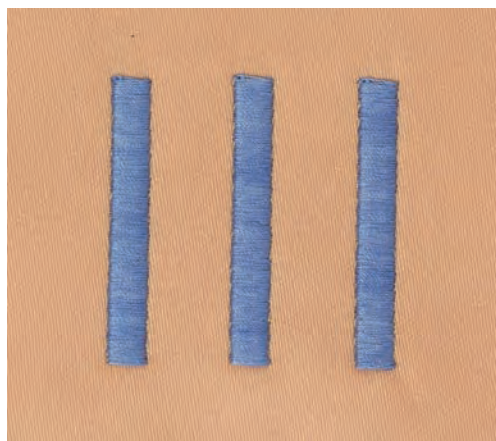

13 Embroidering preparation

13.1 Attaching the Module

NOTICE

Transporting the embroidery module

Damage to the embroidery module connection and machine.

- > Remove the embroidery module before transporting the machine.

Prerequisite:

- The slide-on table must not be attached.
- > Make sure that the module and the machine are placed on a stable, even surface.
- > Make sure that there is enough space around to allow the unimpeded movement of the embroidery arm.
- > Carefully push the embroidery module from left to right into the embroidery module connection of the machine (1) and the guide rail (2).

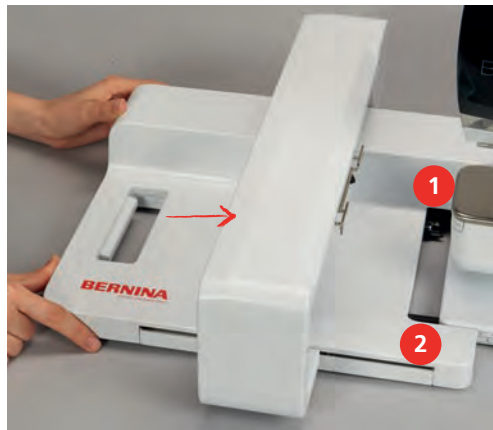

13.2 Removing the embroidery module

- > Push the release lever (1) at the carrying handle of the embroidery module, keep it pressed and at the same time, move the embroidery module carefully to the left.



13.3 Preparing the machine

Lowering the feed dog

- > Push the button «Feed dog up/down» to lower the feed dog.



- > Attach the stitch plate CutWork/Straight (optional accessory).
- > Insert the needle.
- > Attaching the embroidery foot

Selecting an embroidery motif

All embroidery motifs can either be embroidered as-is or edited using the various functions offered by the embroidery machine. All embroidery motifs can be found in the attachment of this instruction manual. In addition to that, embroidery motifs can be loaded from the personal memory or from the BERNINA USB stick (optional accessory).



- > Touch the icon «Home».



- > Touch the icon «Embroidery mode».
- > Select an alphabet, embroidery motif or a personal embroidery motif from a file.

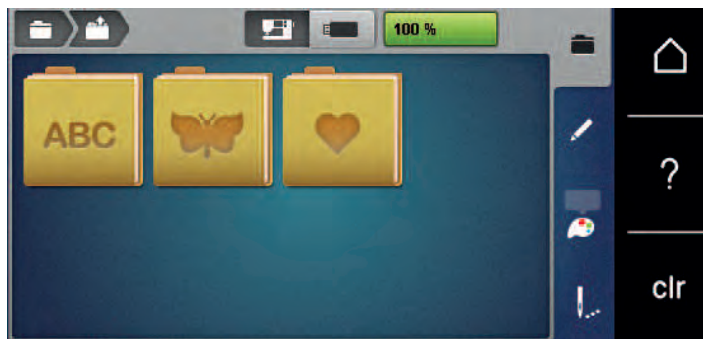

13.4 Embroidery foot

Attaching the embroidery foot

- > Raise the needle.
- > Raise the presser foot.
- > Switch the machine off and disconnect it from the power supply system.
- > Push the clamping lever up (1).

- > Remove the presser foot (2).



- > Insert the embroidery foot from below into the bracket.
- > Press the clamping lever down.



Selecting the presser foot in the User Interface

After having attached the respective embroidery foot (Embroidery foot No. 26, supplied accessory with the embroidery module), you can select and save it on the machine. Moreover, alternative feet are displayed which will also be suitable for the selected embroidery motif.

- > Switch the machine on.
- > Select the embroidery motif.
- > Touch the icon «Presser foot display/Presser foot selection».
- > Select the attached embroidery foot.

A



13.5 Needle and stitch plate

Inserting the embroidery needle



Embroidery needles of the type 130/705 H-SUK provide a larger eye and are slightly rounded. This avoids thread abrasion when using Rayon- and cotton embroidery thread. Depending on the embroidery thread use a size No. 70-SUK to No. 90-SUK needle.

- > Raise the needle.
- > Switch the machine off and disconnect it from the power supply system.
- > Remove the attached foot.
- > Loosen the fixing screw manually.



- > Pull the needle down.
- > Hold the new needle with the flat side to the back.
- > Insert the needle as far as it will go.
- > Tighten the fixing screw manually.

Selecting the embroidery needle in the User Interface

After having changed the needle, it can be checked whether or not it is suitable to be used together with the selected stitch plate.



- > Touch the icon «Needle/Stitch plate selection».
- > Select the attached needle.

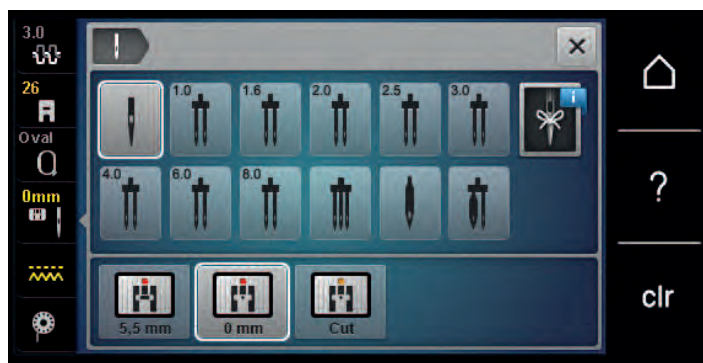

- If the selected needle is suitable in combination with the stitch plate, sewing can be started.
- If the selected needle is not suitable in combination with the stitch plate, starting the machine is automatically prevented.

Selecting the needle type and the needle size

Convenient memory function: To prevent a loss of information, the needle type and the needle size can be saved additionally on the machine. The saved needle type and the saved needle size can be checked at any time.



- > Touch the icon «Stitch plate/Needle selection».

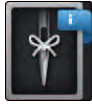

- > Touch the icon «Needle type/Needle size».
- > Select the needle type (1) of the inserted needle.
- > Select the needle size (2) of the inserted needle.



Attaching the stitch plate

The stitch plate CutWork/Straight (optional accessory) has a small hole in the area of the needle insertion. The thread is pulled in and knotted optimally which results in an optimized stitching result.

- > Push the button «Feed dog up/down» to lower the feed dog.



- > Switch the machine off and disconnect it from the power supply system.
- > Remove the needle.
- > Remove the presser foot.
- > Press the stitch plate down at the mark back right until it flips up.



- > Remove the stitch plate.
- > Place the openings of the stitch plate CutWork/Straight above the corresponding guide pins and press down until it clicks into place.

Selecting the stitch plate in the User Interface

After having replaced the stitch plate, it can be checked whether it can be used together with the selected needle.



- > Touch the icon «Stitch plates/Needle selection».
- > Select the stitch plate CutWork/Straight (optional accessory).

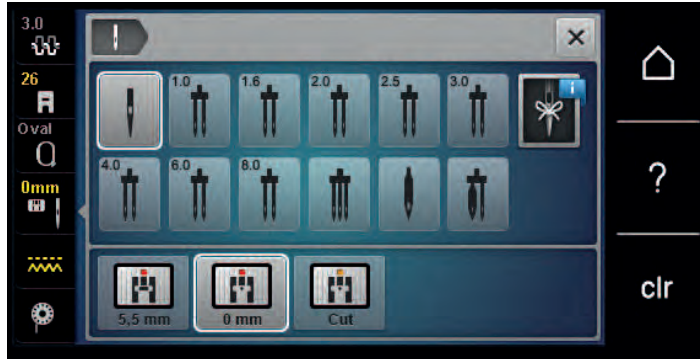

Thread-up command

The machine must be ready for embroidery to bring up the bobbin thread. The bobbin thread can be brought up in one step for a manual knotting. If no securing stitches are wanted, it is recommended to deactivate the securing stitches in the Setup.



- > Hold the upper thread.
- > Press the button «Needle up/down».
 - The bobbin thread is brought up automatically.

13.6 Embroidery hoop

Overview Embroidery hoop selection

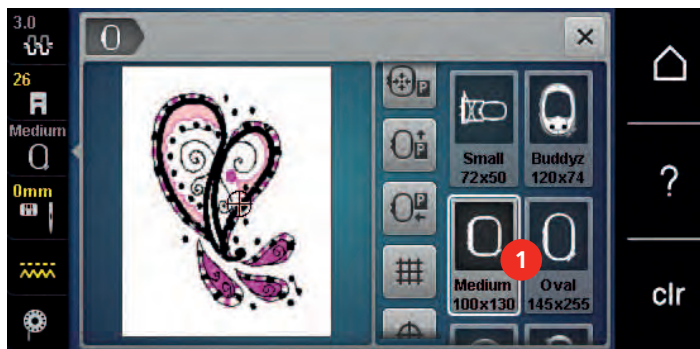

1 Hoop selection

Selecting the embroidery hoop

The best embroidery result is achieved when the smallest possible embroidery hoop for the embroidery motif is selected.

The embroidery motif has a pre-set size which is displayed.

Prerequisite:

- The embroidery motif is selected.



- > Touch the icon «Hoop selection».
 - The machine selects the optimal embroidery hoop according to the size of the embroidery motif automatically. If the pre-set embroidery hoop would not be available, another desired embroidery hoop can be selected. When an embroidery hoop is attached which does not correspond with the selected one, the attached hoop is considered active and the embroidery motif area is displayed accordingly.
- > Select the desired embroidery hoop.

Tear-away stabilizers

Using a stabilizer ensures more stability of the embroidery project. A tear-away stabilizer suits all woven and non-stretch materials. 1 – 2 layers can be used. Stabilizers are available in different weights. With larger embroidered areas the stabilizer will remain under the embroidery thread. The stabilizer is applied to the wrong side of the fabric with temporary adhesive spray. Carefully tear away excess stabilizer after embroidering.

Cut-away stabilizers

Using a stabilizer ensure more stability of the embroidery project. A cut-away stabilizer suits all elastic materials. 1 – 2 layers can be used. Stabilizers are available in different weights. With larger areas to be embroidered the stabilizer will remain under the embroidery thread. The stabilizer is applied to the wrong side of the fabric with temporary adhesive spray. Carefully cut away excess stabilizer after embroidering.

Using adhesive spray

The application of spray adhesive is recommended for stretch and smooth materials and knitware. It prevents the fabric from losing shape and slipping. Appliqués can be exactly positioned with spray adhesive. The spray adhesive shouldn't be used near the machine to avoid contamination.

- > Use the adhesive spray carefully at a distance 25 – 30 cm (9 – 12 inch) when spraying the stabilizer.
- > Adhere the sprayed stabilizer to the wrong side of the fabric carefully, smoothing material so there are no puckers.
- > Position smaller parts such as pocket flaps or collars on the stabilizer.
- > To avoid the possibility of getting hoop marks when working with napped materials or fleece, don't hoop the parts but spray the stabilizer and hoop it.
- > Adhere the fabric to be embroidered.
- > Remove any adhesive residue before starting the machine.

Using spray starch

Spray starch is ideal for additional stiffening fine, loosely woven materials. Always use an additional stabilizer on the wrong side of the material.

- > Spray the area to be embroidered.
- > Let it dry or press gently with a warm iron if necessary.

Using iron-on interfacing

Iron-on interfacings are available in a variety of weights. It is recommended to use an iron-on interfacing which is easily removable from the basic fabric. An Iron-on interfacing suits all materials that are easily distorted like stretch fabric such as tricot and jersey.

- > Iron-on interfacings are ironed to the wrong side of the material using a warm iron.

Using paper-backed adhesive stabilizer

Paper-backed adhesive stabilizers are intended to be used for fabrics such as jersey and silk as well as for embroidery projects which are not suited to be hooped in the embroidery hoop.

- > Place the stabilizer in the hoop, so that the paper side is up.

- > Use a pair of scissors to score the paper and remove paper in the hoop area.
- > Position the fabric to be embroidered on the stabilizer and press it on place.
- > Remove any adhesive residue before starting the machine.

Using water-soluble stabilizer



For lace embroidery it is recommended to hoop 1 – 3 layers of water-soluble stabilizer in the embroidery hoop. As the embroidery motif is not embroidered on the fabric, only the thread embroidered motif is left. The embroidery motifs should be combined with short stitches otherwise the individual motifs may fall out.

The stabilizer dissolves in water. Water-soluble stabilizers are an ideal protection for looped pile fabrics preventing the loops from being damaged! It prevents threads from sinking into the material and keeps the fabric pile from poking through the embroidery. Water-soluble stabilizers are ideal for fine, sheer fabrics where other stabilizers may show through the embroidery stitches as well as for lace embroidery.

- > Place the stabilizer on top of the material.
- > Place all the layers together into the embroidery hoop.
- > Use adhesive spray to adhere stabilizer if necessary.
- > For material with a pile, reinforce with additional, suitable stabilizer on the wrong side. In addition to that a water-soluble stabilizer can be placed on top of the material and fixed with basting stitches.
- > After dissolving, lay the motif down flat and let dry.

Preparing the embroidery hoop

The embroidery hoop consists of an outer and an inner hoop. There is a corresponding template for every hoop. The area to be embroidered is marked in 1 cm (0.39 inch) squares. The center and corner points are marked with holes. The required marks can be transferred to the material.

- > Mark the center of an embroidery motif on the fabric, using a water-soluble pen.

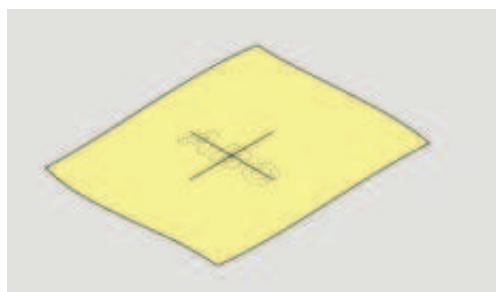

- > Loosen the screw on the outer hoop.
- > Remove the inner hoop.
- > Make sure that the arrows marks of both hoops match.
- > Attach the template holder.
- > Place the template in the inner hoop, so the BERNINA logo is at the front edge at the arrow mark until it clicks into place.

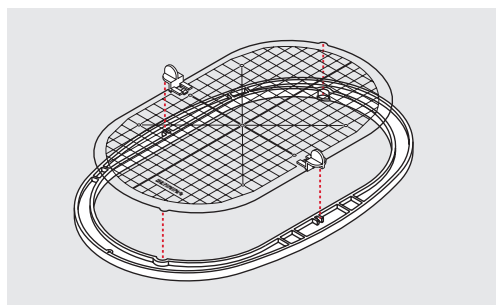

- > Place the material under the inner hoop.
- > Line up the marked center point on the center of the template.

- > Place the material and the inner hoop on the outer hoop so that the arrows of both hoops match.

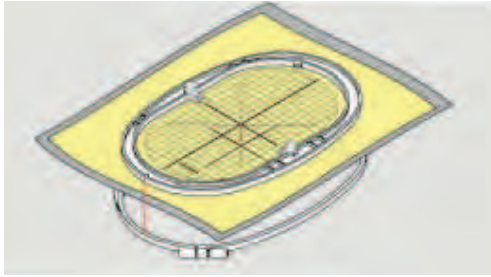

- > Fit the hoops into each other; ensure that the material does not move.
- > Hoop the fabric to be embroidered tightly.
- > Tighten the screw.
- > Remove the template from the hoop by using the template holder.

Attaching the hoop

- > Raise the needle.
- > Raise the embroidery foot.
- > Hold the hoop with the right side of the fabric up with the attaching mechanism to the left.
- > Position the hoop under the embroidery foot.
- > Press both attaching mechanisms (1) of the hoop towards each other.
- > Position the embroidery hoop (2) above the bracket of the embroidery arm.
- > Press the hoop down until it clicks in position.
- > Release the attaching mechanism (1).

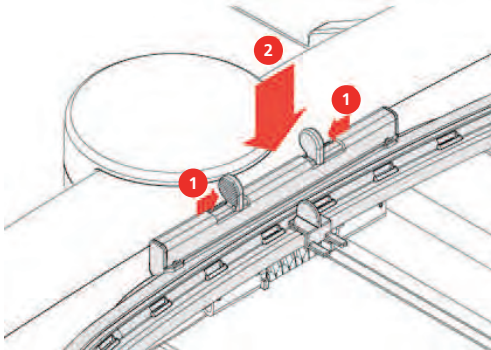

- > Press the attaching mechanisms of the hoop towards each other to remove the hoop.
- > Remove the hoop.

Overview Embroidery functions



- | | | | |
|---|---|---|--|
| 1 | Centering the embroidery hoop to the needle | 4 | Grid on/off |
| 2 | Moving the hoop to the back | 5 | Motif center |
| 3 | Moving the module for the sewing mode | 6 | Virtual Positioning (is visible while scrolling) |

Center the needle to the embroidery hoop

Relocating the embroidery hoop facilitates threading when the needle is close to the embroidery hoop.



- > Touch the icon «Embroidery hoop display/Embroidery hoop selection».



- > Touch the icon «Center the needle to the embroidery hoop».
- > Threading the upper thread.



- > Push the button «Start/Stop» to move the embroidery hoop back to the last position.

Moving the hoop to the back

To facilitate changing the bobbin, it is recommended to move the hoop to the back before threading. This makes it easier to open the bobbin cover.



- > Touch the icon «Embroidery hoop display/Embroidery hoop selection».

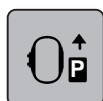

- > Touch the icon «Move the hoop to the back».
- > Thread the bobbin thread (see page 50).



- > Push the button «Start/Stop» to move the embroidery hoop back to the last position. Pull the upper thread back if necessary.

Moving the module for the sewing mode

The embroidery module can be positioned so that any sewing projects can be carried out even if the module is connected.



- > Touch the icon «Embroidery hoop display/Embroidery hoop selection».
- > Remove the hoop.



- > Touch the icon «Move the module for the sewing mode».



> Touch the icon «Home».



> Touch the icon «Sewing mode».

Grid on/off

When the center of the hoop and the grid are displayed, the embroidery motif can be positioned more exactly.



> Touch the icon «Embroidery hoop display/Embroidery hoop selection».

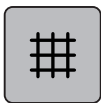

- > Touch the icon «Grid on/off» to display the center of the hoop on the display.
- > Touch the icon «Grid on/off» again to display the grid.
- > Touch the icon «Grid on/off» again so that the center of the hoop and the grid disappear.

Locating the center of the embroidery motif

The embroidery hoop is positioned so that the needle is exactly above the center of the embroidery motif or the motif begin.



> Touch the icon «Embroidery hoop display/Embroidery hoop selection».



- > Touch the icon «Center of the embroidery motif» to position the hoop so that the needle is placed exactly over the center of the embroidery motif.
- > Touch the icon «Center of the embroidery motif» again to position the hoop so that the needle is placed exactly over the motif start.

Virtual positioning of the embroidery hoop

The embroidery hoop is automatically moved to the new position as soon as the embroidery motif is repositioned. Therefore the icon «Virtual positioning» is activated automatically and outlined in yellow when an embroidery hoop is attached.

Prerequisite:

- The hoop is attached.



> Touch the icon «Embroidery hoop display/Embroidery hoop selection».



- > Touch the icon «Virtual positioning» to deactivate the automatic movement of the hoop when having repositioned the embroidery motif.
- > Touch the icon «Virtual positioning» again to activate the automatic movement of the hoop when having repositioned the embroidery motif.

14 Setup Program

14.1 Adjusting the embroidery settings in the Setup Program

Further information about this topic (see page 56).



15 Creative embroidering

15.1 Overview embroidering

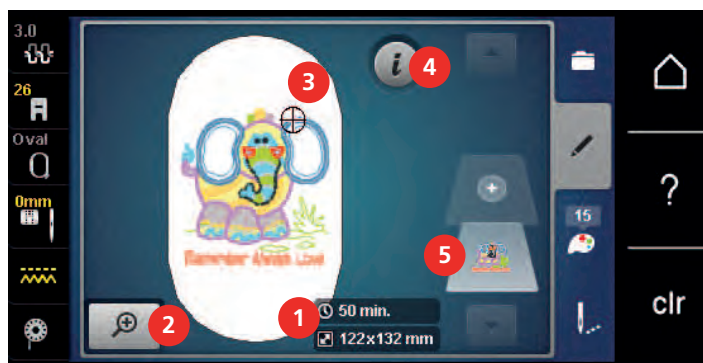

- | | | | |
|---|---|---|-------------------------|
| 1 | Embroidery time/Embroidery motif size in mm | 4 | «i»-Dialog |
| 2 | Scaling up, downsizing and moving the embroidery motif view | 5 | Embroidery motif layers |
| 3 | Area to be embroidered | | |

15.2 Selecting and changing the embroidery motif



- > Touch the icon «Selection».



- > Touch the icon «Upload embroidery motif».
- > Select a new embroidery motif.

15.3 Checking the embroidery time and the embroidery motif size

In the display «Edit» at lower right (1), the estimated embroidery time is indicated in minutes and the width and height of the embroidery motif is indicated in millimeters.

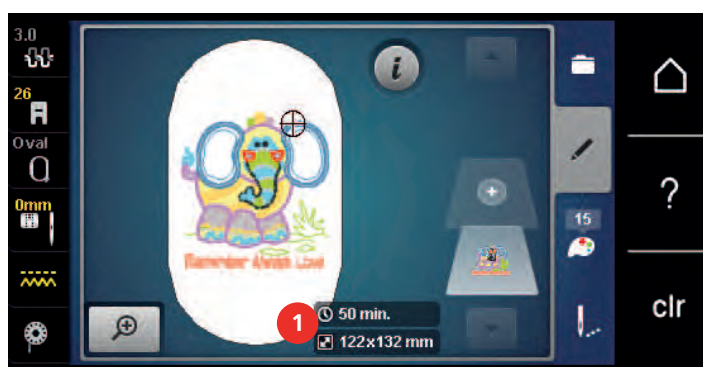

15.4 Regulating the speed

The speed is infinitely variable with the slide-speed control.



- > Move the slide-speed control to the left to reduce the speed.
- > Move the slide-speed control to the right to increase the speed.

15.5 Editing the embroidery motif

Overview Editing embroidery motif

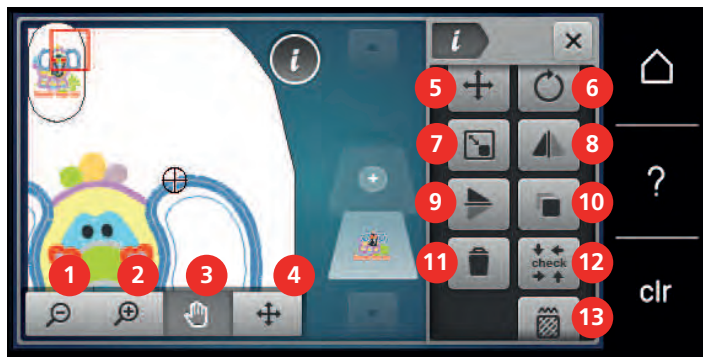

- | | | | |
|---|-------------------------------|----|---|
| 1 | Zoom out | 8 | Mirror image left/right |
| 2 | Zoom in | 9 | Mirror image up/down |
| 3 | Moving the view | 10 | Duplicating |
| 4 | Moving the motif | 11 | Deleting |
| 5 | Moving the motif | 12 | Check embroidery motif size |
| 6 | Rotating the embroidery motif | 13 | Altering the stitch type/stitch density |
| 7 | Altering the size | | |

Scaling up the embroidery motif view

The view of the embroidery motif can be scaled up. In addition to that, the view can be adjusted with or without changing the embroidery position.

- > Select an embroidery motif.
- > Touch the icon «Zoom in» to edit the view of the embroidery motif.



- > Touch the icon «Zoom in» 1 – 4 times to enlarge the view of the embroidery motif gradually.



- > Touch the icon «Zoom out» 1 – 5 times to get back to the Edit Mode.



Downsizing the embroidery motif view

The view of the embroidery motif can be downsized. In addition to that, the view can be adjusted with or without changing the embroidery position.

- > Select the embroidery motif.
- > Touch the icon «Zoom in» to edit the view of the embroidery motif view.



- > Touch the icon «Zoom in» 1 to 4 times to downsize the view of the enlarged embroidery motif gradually.





Moving the embroidery motif view

The view of the embroidery motif can be moved. In addition to that, the view can be adjusted with or without changing the embroidery position.



- > Select an embroidery motif.
- > Touch the icon «Zoom in» to activate the icon «Move the view».



-  > Touch the icon «Move the view».
 - The icon turns dark gray.
- > Move the view of the embroidery motif using the touchscreen pen/finger.
 - The embroidery position is not altered.
-  > Touch the icon «Zoom out» to go back to the Edit Mode.

Moving the embroidery motif in enlarged view

The view of the embroidery motif can be moved. In addition to that, the view can be adjusted with or without changing the embroidery position.

- > Select an embroidery motif.
-  > Touch the icon «Zoom in» to activate the icon «Move the motif».
-  > Touch the icon «Move the stitch pattern».
 - > Move the view of the embroidery motif using the touchscreen pen/finger.
 - The embroidery position is altered.
-  > Touch the icon «Zoom out» to go back to the Edit Mode.

Moving the embroidery motif

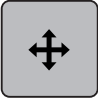
- > Select an embroidery motif.
-  > Touch the icon «i»-Dialog.
-  > Touch the icon «Move the stitch pattern».
 - > Turn the «Upper Multifunction knob» to move the embroidery motif horizontally in 1/10-mm steps.
 - > Turn the «Lower Multifunction knob» to move the embroidery motif vertically in 1/10-mm steps or
 - > touch the embroidery motif, keep it pressed and move it as you like.
 - The relocation is indicated in the yellow-framed icons.



-  > Touch the icon «Center of the embroidery motif».
 - The embroidery motif is repositioned in the center of the embroidery hoop.

Rotating motif

- > Select an embroidery motif.
-  > Touch the icon «i»-Dialog.



- > Touch the icon «Rotate the motif».
- > Turn the «Upper Multifunctional knob» or the «Lower Multifunctional knob» to the right to rotate the embroidery motif clockwise.
- > Turn the «Upper Multifunctional knob» or the «Lower Multifunctional knob» to the left to rotate the embroidery motif counter-clockwise.



- > Touch the icon «Rotate the motif +90°» to rotate the embroidery motif in 90°-steps.

Altering the embroidery motif size proportionally

If the icon «Retain the proportions» is framed in white, the embroidery motif is altered proportionally.



- > Select an embroidery motif.
- > Touch the icon «i»-Dialog.



- > Touch the icon «Alter the embroidery size».
- > Turn the «Upper/Lower Multifunctional knob» to the right to scale up the embroidery motif proportionally.
- > Turn the «Upper/Lower Multifunctional knob» to the left to downsize the embroidery motif proportionally.



Altering the embroidery motif size disproportionally

If the icon «Retain the proportions» is **not** outlined in white, the embroidery motif is altered disproportionally.



- > Select an embroidery motif.
- > Touch the icon «i»-Dialog.



- > Touch the icon «Alter the embroidery motif size» to alter the embroidery motif width and height independent on each other.



- > Touch the icon «Retain the proportions».
- > Turn the «Upper Multifunctional knob» to alter the embroidery motif horizontally.

- > Turn the «Lower Multifunctional knob» to alter the embroidery motif vertically.
 - The embroidery motif is **not** scaled up or downsized proportionally.

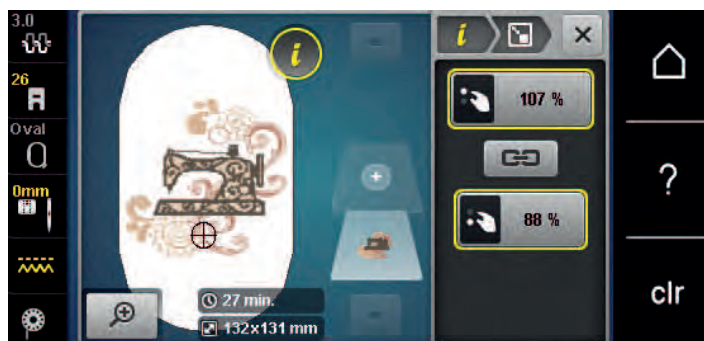

Mirroring embroidery motifs

Embroidery motifs can be mirror-imaged both vertically and horizontally.

- > Select an embroidery motif.
- > Touch the icon «i»-Dialog.



- > Touch the icon «Mirror image left/right» to mirror the embroidery motif vertically.



- > Touch the icon «Mirror image up/down» to mirror the embroidery motif horizontally.

Bending the text

Texts can be arranged and designed arc-shaped.

- > Create an alphabet embroidery motif.
- > Touch the icon «i»-Dialog.



- > Touch the icon «Bend text».
- > Turn the «Upper Multifunctional knob» to alter the distance between the characters in millimeter-steps.
- > Turn the «Lower Multifunctional knob» to the left or to the right to bend the lettering upwards or downwards.

Changing the stitch type

If the satin stitches are too long, they can be changed to step stitches.

- > Select an embroidery motif.
- > Touch the icon «i»-Dialog.



- > Touch the icon «Change the stitch type».
- > Touch the switch in the upper section of the display (1) to change the satin stitch to the step stitch.

- > Adjust the desired stitch length (2) with the icons «-» or «+».



Altering the stitch density

If the satin stitches are embroidered too densely, the stitch density can be adjusted.

- > Select an embroidery motif.
- > Touch the icon «i»-Dialog.



- > Touch the icon «Change the stitch type».
- > Adjust the desired stitch density (1) with the icons «-» or «+».



Checking the size and the position of the embroidery motif

It can be checked whether or not the embroidery motif matches the designated position/location on the fabric. Points which are beyond the embroidery hoop are not traveled to.

- > Select an embroidery motif.
- > Touch the icon «i»-Dialog.



- > Touch the icon «Check embroidery motif size».
 - The embroidery hoop travels all the way until the needle is at the position as it is indicated in the display.
- > Touch the icon «Corner top left» to select the top left corner of the embroidery motif.
 - The embroidery hoop travels all the way until the needle is at the position as it is indicated in the display.
- > Touch the icon «Corner top right» to select the top right corner of the embroidery motif.
 - The embroidery hoop travels all the way until the needle is at the position as it is indicated in the display.

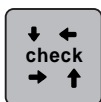

- > Touch the icon «Corner bottom left» to select the bottom left corner of the embroidery motif.
 - The embroidery hoop travels all the way until the needle is at the position as it is indicated in the display.
- > Touch the icon «Corner bottom right» to select the bottom right corner of the embroidery motif.
 - The embroidery hoop travels all the way until the needle is at the position as it is indicated in the display. If the embroidery motif hasn't been positioned correctly yet, the position can be altered via the «Upper/Lower Multifunction knobs» and the complete embroidery positions can be checked again.

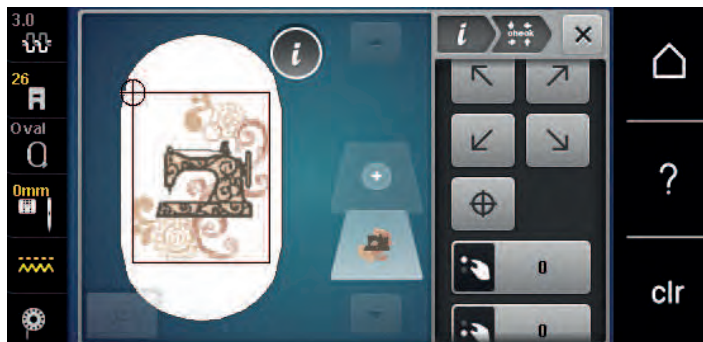

- > Touch the icon «Embroidery motif center» to bring the needle to the center of the embroidery motif.
- > Turn the «Upper Multifunctional knob» to move the embroidery motif horizontally.
- > Turn the «Lower Multifunctional knob» to move the embroidery motif vertically.

Duplicating the embroidery motif

The active embroidery motif is duplicated.



- > Select an embroidery motif.
- > Touch the icon «i»-Dialog.



- > Touch the icon «Duplicate».

Deleting an embroidery motif

The active embroidery motif is deleted.



- > Select an embroidery motif.
- > Touch the icon «i»-Dialog.



- > Touch the icon «Delete».

15.6 Combining embroidery motifs

Combining embroidery motifs

In the Combi-Mode several embroidery motifs can be combined.

- > Select an embroidery motif.



- > Touch the icon «Add an embroidery motif» (1).
- > Select another embroidery motif.

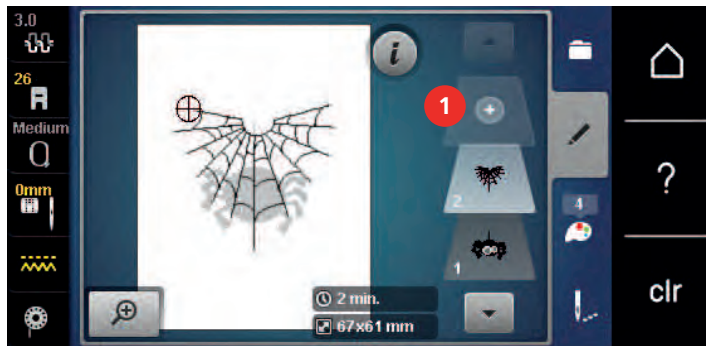

Deleting a single embroidery motif

Prerequisite:

- A combination of embroidery motifs has been created.
- > In the section of the embroidery motif level (1) touch the desired embroidery motif with the finger, keep it pressed and move it outwards.
 - A new window opens.

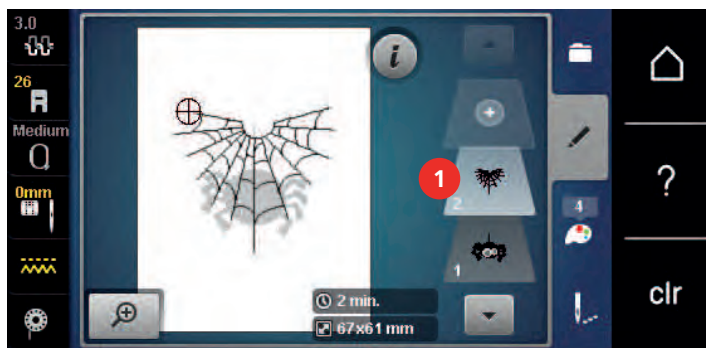

- > Touch the icon «Confirm» to delete the selected embroidery motif.

Duplicating the embroidery motif

- > Select an embroidery motif.
- > Touch the icon «i»-Dialog.



- > Touch the icon «Duplicate».
 - The embroidery motif (1) is duplicated (2).

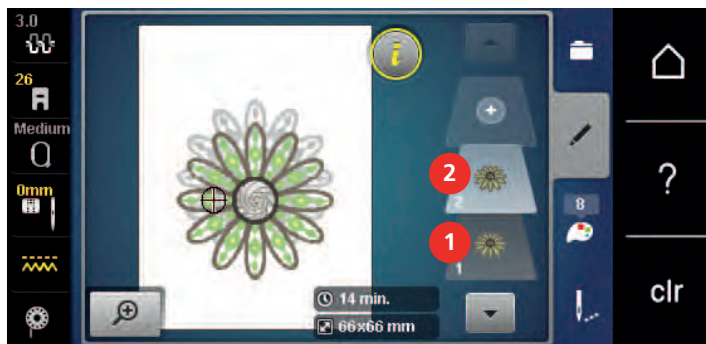

Duplicating a combination

When a combination is duplicated, the individual embroidery motifs cannot be selected anymore.

- > Select an embroidery motif.
- > Touch the icon «Add an embroidery motif».
- > Select another embroidery motif.
- > Select the combination (1).

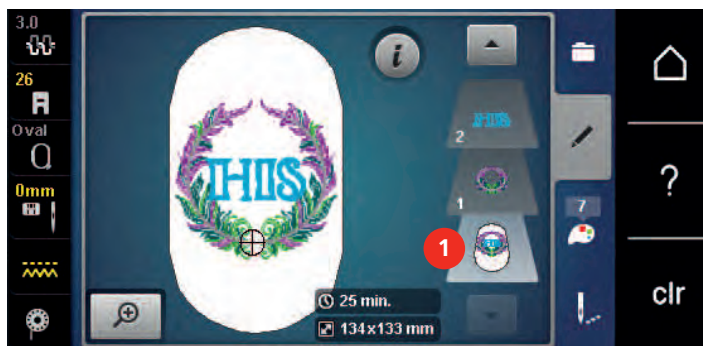

- > Touch the icon «i»-Dialog.



- > Touch the icon «Duplicate».

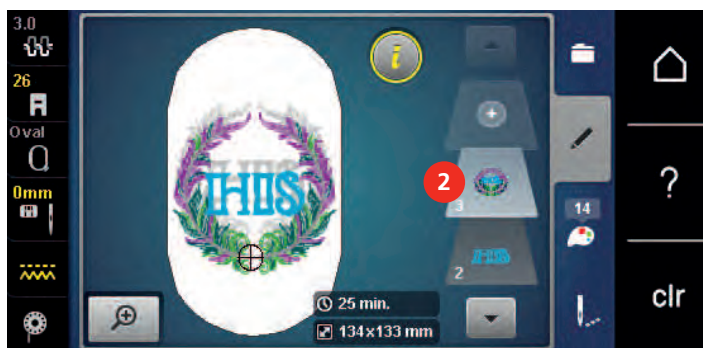

- The combination is duplicated (2).

15.7 Creating lettering

Overview embroidery alphabets

Embroidery motif	Name
ABC	Swiss Block
<i>ABC</i>	Anniversary
АБВ	Russian Textbook
ABC	Rounded Sans

Creating words/sentences



Lettering is always embroidered in one color. To embroider single letters or single words in another color, every letter or every word has to be selected individually and placed in the area to be embroidered.

Lettering can be positioned within the hoop as you like. When the embroidery motif is positioned outside the embroidering area, the hoop is outlined in red on the display. With the hoop selection it can be checked whether or not the embroidery motif can be embroidered in another hoop. When the lettering does not fit in any hoop, two single words can be combined and positioned below each other as the following example will show.



- > Select the file «Alphabets».
- > Select the font.
- > Enter the text «Made to».
- > Touch the icon (1) (standard setting) to use upper case letters.
- > Touch the icon (2) to use lower case letters.
- > Touch the icon (3) to use numbers and mathematic characters.
- > Touch the icon (4) to use special characters.



- > Touch the text box above the keyboard to delete the entered text completely.
- > Touch the icon «DEL» to delete single letters of the entered text.



- > Touch the icon «Confirm» to accept the text.



- > Touch the icon «Embroidery hoop display/Embroidery hoop selection».
- > Select the hoop.
- > Touch the icon «Embroidery hoop display/Embroidery hoop selection» again to go back to the Edit Mode.

Editing words/sentences



- > Touch the icon «i»-Dialog.

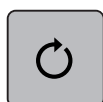

- > Touch the icon «Rotate the motif».



- > Touch the icon «+90» to rotate the text by 90°.
- > Touch the icon «i» (1).

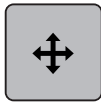

- > Touch the icon «Move the stitch pattern».
- > Turn the «Upper Multifunctional knob» to move the embroidery motif horizontally.
- > Turn the «Lower Multifunctional knob» to move the embroidery motif vertically.



- > Touch the icon «Add motif».
- > Enter and also rotate the text «create».



- > Touch the icon «Embroidery hoop display/Embroidery hoop selection».

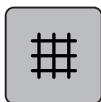

- > Touch the icon «Grid on/off» to position the text lines more exactly.

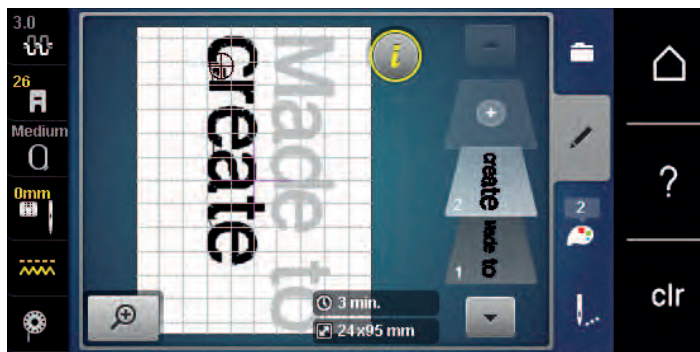

15.8 Changing the colors of the embroidery motif

Overview changing the color

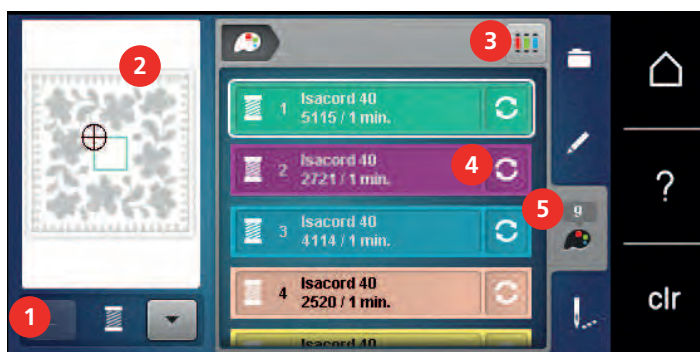

- | | | | |
|---|-----------------------------|---|----------------------|
| 1 | Colors of embroidery motifs | 4 | Altering color/brand |
| 2 | Preview for selected color | 5 | Color information |
| 3 | Allocating thread brand | | |

Changing the colors



Lettering is always embroidered in one color. To embroider single letters or single words in another color, every letter or every word has to be selected individually and placed in the area to be embroidered.



- > Select the embroidery motif.
- > Touch the icon «Color information».



- > Touch the icon «Alter Color/Brand» next to the color which is to be changed.
- > Swive upwards or downwards on the display with the touchscreen pen/finger to see more colors.



- > Touch the icon «Color selection by number» to select the color by entering the color number.
- > Select the desired color.
- > The color selection needs to be confirmed by touching the color bar on the left side.

Changing the thread brand



- > Select an embroidery motif.
- > Touch the icon «Color information».

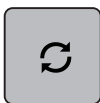

- > Touch the icon «Altering color/brand».



- > Touch the icon «Scroll left/right» to display other thread brands.



- > Touch the icon «Allocate thread brand».
 - Any thread colors of the selected embroidery motif will be matched with the selected thread brand.

15.9 Embroidering the embroidery motif

Overview Embroidery menu



- | | | | |
|---|--|---|---|
| 1 | Basting | 5 | Multi-colored embroidery motif on/off |
| 2 | Moving the hoop | 6 | Embroidery speed (appears by scrolling) |
| 3 | Embroidery sequence control when thread breaks | 7 | Reducing color changes (appears by scrolling) |
| 4 | Cutting connecting stitches | 8 | Color indication |

Adding basting stitches

The basting stitches can be embroidered along the embroidery hoop or along the embroidery motif. Therefore the connection between the fabric and the stabilizer can be improved.

- > Select an embroidery motif.
- > Touch the icon «Embroidering».



- > Touch the icon «Basting» to embroider basting stitches along the embroidery motif.
- > Touch the icon «Basting» again to embroider basting stitches along the embroidery hoop.
- > Touch the icon «Basting» again to deactivate the basting stitches.



Moving the hoop

If the embroidery motif is so big that repeated rehooping is necessary, the embroidered motif can be moved again.

- > Select an embroidery motif.
- > Touch the icon «Embroidering».



- > Touch the icon «Move the hoop».
- > Turn the «Upper Multifunctional knob» to move the hoop horizontally.
- > Turn the «Lower Multifunctional knob» to move the hoop vertically.



Embroidery sequence control when thread breaks

When the thread breaks, the needle can be repositioned in the embroidery motif by means of the embroidery sequence control.

- > Select an embroidery motif.



- > Touch the icon «Embroidering».



- > Touch the icon «Embroidery sequence control when thread breaks».
 - In the left portion of the display a compact view of the embroidery motif is displayed. On the right side the enlarged embroidery motif is displayed.
- > Select the desired position in the compact view using the touchscreen pen/finger.
- > Turn the «Upper Multifunctional knob» to move the hoop stitch by stitch.
- > Turn the «Lower Multifunctional knob» to move the hoop in large steps.
 - The number in the yellow-framed icon indicates the number of stitches within the embroidery sequence.



- > Touch the icon «Magnifier» to select the desired stitch via entry.

Cutting connecting stitches

The function is activated by default and the connecting stitches are cut automatically. When the function is deactivated, the connecting stitches between the embroidery motifs must be cut manually.

- > Select an embroidery motif.
- > Touch the icon «Embroidering».



- > Touch the yellow-framed icon «Cut the connecting stitches» to deactivate the function.
- > Touch the icon «Cut the connecting stitches» again to activate the function.

Reducing color changes

When the embroidery motifs overlap, the color changes **cannot** be reduced.

- > Select an embroidery motif.
- > Touch the icon «Embroidering».



- > Touch the icon «Reduce thread change».
 - Identical colors of the embroidery motif are collected to one color.

Multi-colored embroidery motif on/off

Multi-colored embroidery motifs can also be embroidered in one color.

- > Select an embroidery motif.
- > Touch the icon «Embroidering».

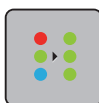

- > Touch the icon «Multi-colored embroidery motif on/off».
 - The embroidery motif is embroidered in one color.

Color indication

Every color of the embroidery motif can be selected individually. The hoop moves to the first stitch of the current color. The currently active color can be embroidered individually or in another sequence.



- > Select an embroidery motif.
- > Touch the icon «Embroidering».



- > Touch the icon «Scroll down» to select the next color of the embroidery motif.



- > Touch the icon «Scroll up» to select the previous color of the embroidery motif.

15.10 Free arm embroidering

Free arm embroidering is defined as embroidering tubular fabrics or garments which are positioned around the free arm of the embroidery machine while being embroidered. Often used with sleeves, pant legs or other narrow-tailored garments.



A tubular piece of fabric can be pulled over the free arm of the machine easily when the free arm is positioned to the left in parking position before the hoop is attached or removed. Push the button «Start/Stop» to move the embroidery hoop back to the embroidery position again.

Make sure to use a full bobbin as the embroidery hoop needs to be removed for changing the bobbin.

The movability of the embroidery arm can be limited or impeded with very narrow tubes. Therefore please make sure that the embroidery hoop can move forwards and backwards sufficiently. An impediment of the embroidery arm caused by a tube which is too tight can result in embroidery motif offset or in damaging the fabric.

Check the movability of the free arm

- > Open the embroidery motif on the machine and edit as desired.
- > Mark the embroidery motif position and the size on the fabric in a suitable way.
- > Select the embroidery hoop as small as possible.
- > Hoop or stick the fabric along with the appropriate stabilizer in the embroidery hoop, depending on the stabilizer.
- > Pull the fabric tube carefully over the free arm of the machine and attach the embroidery hoop at the clutch of the embroidery module.
- > If necessary, reposition the embroidery motif.
- > Previously check whether the embroidery hoop can be moved forwards and backwards according to the embroidery motif size.
- > Touch the icon «Check embroidery motif size».
- > After the successful check of the embroidery motif size, start the embroidery process.
 - You can find detailed instructions about embroidery, how to use appropriate materials or how to select the required embroidery settings on the machine in the «Tutorial» under embroidery techniques --> Embroidery.

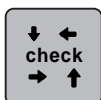

15.11 Administering embroidery motifs

Administering embroidery motifs

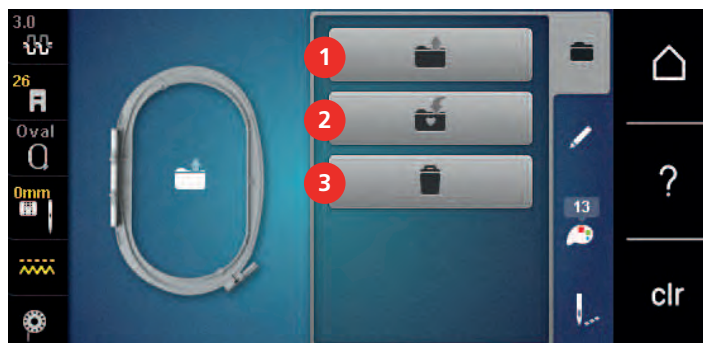

- | | | | |
|---|------------------------------|---|----------|
| 1 | Loading the embroidery motif | 3 | Deleting |
| 2 | Saving the embroidery motif | | |

Saving embroidery motifs in the personal memory

In the filing system «Personal memory» any stitch patterns, also those which have been individually edited, can be saved.

- > Select an embroidery motif.
- > Edit the embroidery motif.
- > Touch the icon «Selection».



- > Touch the icon «Save the motif».
 - The embroidery motif to be saved is outlined in yellow.
 - The icon «Embroidery machine» is activated.



- > Touch the icon «Confirm».

Saving the embroidery motif on the BERNINA USB stick

- > Select an embroidery motif.
- > Edit the embroidery motif.
- > Touch the icon «Selection».



- > Touch the icon «Save the motif».
 - The embroidery motif to be saved is outlined in yellow.

- > Insert the BERNINA USB stick into the USB port of the machine.



- > Touch the icon «USB stick».



- > Touch the icon «Confirm».

Overwriting the embroidery motif in the personal memory

- > Select an embroidery motif.
- > Edit the embroidery motif.
- > Touch the icon «Selection».



- > Touch the icon «Save the motif».
 - The embroidery motif to be saved is outlined in yellow.



- Touch the icon «Embroidery machine» is activated.



- > Select the embroidery motif which is to be overwritten.

- > Touch the icon «Confirm».



Overwriting the embroidery motif on the BERNINA USB stick

- > Select an embroidery motif.
- > Edit the embroidery motif.
- > Touch the icon «Selection».



- > Touch the icon «Save the motif».
 - The embroidery motif to be saved is outlined in yellow.



- > Insert the BERNINA USB stick into the USB port of the machine.

- > Touch the icon «USB stick».

- > Select the embroidery motif which is to be overwritten.

- > Touch the icon «Confirm».



Importing stitch patterns

Stitch patterns or stitch pattern combinations can be imported from the Sewing mode to the Embroidery mode and edited like embroidery motifs. Therefore endless embroidery can be combined quickly and easily and saved as an embroidery motif in the file «Personal embroidery motifs».

- > Touch the icon «Home».



- > Touch the icon «Sewing mode».
- > Select a stitch pattern.



- > Touch the icon «Home».



- > Touch the icon «Embroidery mode».
 - The stitch pattern is saved automatically in the file «Personal embroidery motifs».



- > Select the file «Personal embroidery motifs».
- > Select an embroidery motif.



Loading an embroidery motif from the personal memory



> Touch the icon «Selection».



> Touch the icon «Upload embroidery motif».



> Select the file «Personal embroidery motifs».
> Select an embroidery motif.

Loading an embroidery motif from the BERNINA USB stick



> Touch the icon «Selection».
> Insert the BERNINA USB stick into the USB port of the machine.



> Touch the icon «USB stick».
> Select a personal embroidery motif.

Deleting an embroidery motif from the personal memory

The embroidery motifs which are saved in the personal memory can be deleted individually. In the Setup Program all your personal embroidery motifs can be deleted.



> Touch the icon «Selection».



> Touch the icon «Delete».



– Touch the icon «Embroidery machine» is activated.

> Select the embroidery motif which is to be deleted.



> Touch the icon «Confirm».

Deleting an embroidery motif from the BERNINA USB stick



> Touch the icon «Selection».



> Touch the icon «Delete».
> Insert the BERNINA USB stick into the USB port of the machine.



> Touch the icon «USB stick».
> Select the embroidery motif which is to be deleted.



> Touch the icon «Confirm».

16 Embroidery

16.1 Embroidering via the button «Start/Stop»

In case of a power cut the embroidery process is interrupted. After the restart the machine goes to the position which was embroidered last.



- > Push the button «Start/Stop» to start the embroidery machine.
 - The machine will stop after about 7 stitches.
- > Raise the embroidery foot.
- > Cut the bobbin thread according to the animation in the display and touch the icon «OK» to confirm.



- > Lower the embroidery foot.
- > Press the button «Start/Stop» to continue embroidering.

16.2 Increasing the embroidery speed

To ensure the best embroidery quality, the speed when embroidering is reduced depending on the embroidery position. Choose between the two options to either embroider at optimal or maximum speed. Standard = optimal speed. It has to be considered that the quality of the embroidered embroidery motif at maximum speed cannot be ensured.

By switching the machine off and on, the optimal embroidery speed is activated.

Prerequisite:

- The embroidery motif has been selected and the embroidering has started.



- > Touch the icon «Embroidery speed».
 - The maximum speed is activated.
- > Touch the icon «Embroidery speed» again.
 - The optimal speed is activated.

16.3 Adjusting the upper thread tension

The default setting of the upper thread tension is provided automatically as soon as a stitch pattern or an embroidery motif is selected.

The upper thread tension is set optimally at the BERNINA factory and the machine has been tested. Metrosene-/Seralon thread size 100/2 (Company Mettler, Switzerland) is used for upper and bobbin thread.

When of using other types of sewing or embroidery threads, the optimal tension may vary. Therefore it may be necessary to adjust the upper thread tension according to the sewing or embroidering project as well as the desired stitch pattern or the embroidery motif individually.

The higher the upper thread tension, the tighter the upper thread which means that the bobbin thread is pulled up to the top of the fabric. When the upper thread tension is low, the upper thread is less tightened which means that the bobbin thread is pulled up less.

Alterations of the upper thread tension affect the currently selected stitch pattern or embroidery motif. Permanent alterations of the upper thread tension for the sewing mode (see page 54) and for the embroidering mode (see page 56) can be made in the Setup Program.

Prerequisite:

- In the Setup Program the upper thread tension has been altered.



- > Touch the icon «Upper thread tension».
- > Move the slide using the touchscreen pen/finger to increase or reduce the upper thread tension.



- > Touch the yellow-framed icon on the right side to reset the alterations to default setting.
- > Touch the yellow-framed icon on the left side to reset the alterations to default setting in the **Setup Program**.

16.4 Embroidering via the foot control

Embroidering via the foot control is recommended when only a short sequence has to be embroidered. While embroidering, the foot control must be pressed down all the time.

- > Press the foot control to start embroidering.

17 Attachment

17.1 Maintenance and cleaning

Cleaning the display

- > Clean the display when it is switched off with a soft slightly damp microfiber cloth.

Cleaning the feed dog



Electronically driven components

Risk of injury near the needle and the hook.

- > Switch the machine off and disconnect it from the power supply system.

Remove the thread remnants under the stitch plate regularly.

- > Remove the presser foot and the needle.
- > Push the button «Feed dog up/down» to lower the feed dog.



- > Remove the stitch plate.
- > Clean the feed dog with the brush.

Cleaning the hook



Electronically driven components

Risk of injury near the needle and the hook.

- > Switch the machine off and disconnect it from the power supply system.

- > Open the bobbin cover.
- > Remove the bobbin case.
- > Push the fastening bracket to the left.



- > Flap down the fastening bracket along with the black hook race cover.

- > Remove the hook.

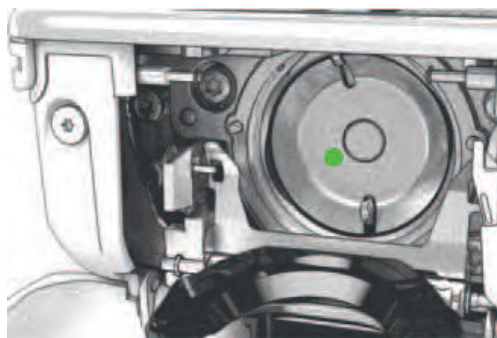

- > Clean the hook race with a brush; do not use any pointed objects.
- > Hold the hook at the pin in the center with two fingers.
- > Lead the hook, lower edge ahead, angular top-down behind the hook race cover.
- > Position the hook with the two lugs meeting the openings in the hook, the colored mark on the hook driver should be visible through the hole in the hook.
- > Insert the hook.
 - The hook is magnetic and therefore fastened to the correct position.
- > Close the hook race cover and the fastening bracket until the release bracket engages.
- > As a check, turn the handwheel.
- > Insert the bobbin case.

Lubricating the hook



CAUTION

Electronically driven components

Risk of injury near the needle and the hook.

- > Switch the machine off and disconnect it from the power supply system.

NOTICE

Lubricating the hook

Too much oil can pollute the fabric and the thread.

- > Always embroider a test piece first.

- > Remove the bobbin case.
- > Press the release lever to the left.



- > Flap down the fastening bracket along with the black hook race cover.

- > Remove the hook.

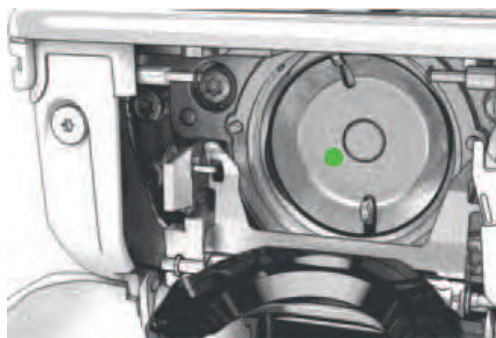

- > Give one drop of BERNINA oil down in the hook race.

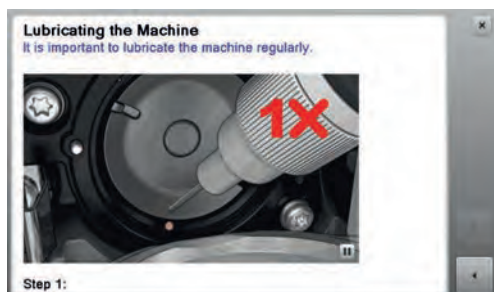



- > Give one drop of oil in each of the two oil depots so that the felts are damp and make sure that the red-marked surface of the hook sleeve remains free of oil.



- > Hold the hook at the pin in the center with two fingers.
- > Lead the hook, lower edge ahead, angular top-down behind the hook race cover.
- > Position the hook with the two lugs meeting the openings in the hook, the colored mark on the hook driver should be visible through the hole in the hook.
- > Insert the hook.
 - The hook is magnetic and therefore fastened to the correct position.
- > Close the hook race cover and the fastening bracket until the release bracket engages.
- > As a check, turn the handwheel.
- > Insert the bobbin case.







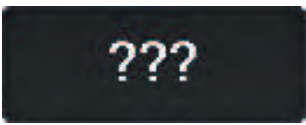

17.2 Troubleshooting

Fault	Cause	Repair
Uneven stitch formation	Upper thread too tight or too loose.	> Adjust upper thread tension.
	Needle blunt or bent.	> Replace the needle, make sure that a new BERNINA quality needle is used.
	Poor quality needle.	> Use a new BERNINA quality needle.
	Poor quality thread.	> Use quality thread.
	Incorrect needle/thread combination.	> Match the needle with the thread size.
	Incorrectly threaded.	> Rethread.
	The fabric has been pulled.	> Feed the fabric evenly.
Uneven stitch formation	Incorrect bobbin case is used.	> Use the supplied bobbin case with triangles.
		
Skipped stitches	Incorrect needle.	> Use the needle system 130/705H.
	Needle blunt or bent.	> Replace the needle.
	Poor quality needle.	> Use a new BERNINA quality needle.
	The needle is incorrectly inserted.	> Insert the needle with the flat side to the back as far up as it will go into the needle holder and tighten the screw.
	Incorrect needle point.	> Match the needle point to the texture of the material.
Faulty stitching	Thread remnants between the thread tension discs.	> Fold a piece of thin material and slide the folded edge (not the raw edges) between the thread tension discs.
	Incorrectly threaded.	> Rethread.
	Thread remnants below the bobbin case spring.	> Remove the thread remnants under the spring.



Fault	Cause	Repair
Upper thread breaks	Incorrect needle/thread combination.	> Match the needle with the thread size.
	Upper thread is too tight.	> Reduce the upper thread tension.
	Incorrectly threaded.	> Rethread.
	Poor quality thread.	> Use quality thread.
	The stitch plate or the hook tip is damaged.	> Contact the nearest specialized BERNINA dealer to have the damages repaired. > Replace the stitch plate.
	The thread is caught in the area of the thread take-up lever.	> Slide the headframe (1) to the left, then remove it. > Remove the thread remnants. > Insert the 4 knobs of the headframe into the provided notches and slide the headframe to the right.
		
Lower thread breaks	The bobbin case is damaged.	> Replace the bobbin case.
	The stitch hole in the stitch plate is damaged.	> Contact the nearest specialized BERNINA dealer to have the damages repaired. > Replace the stitch plate.
	Needle blunt or bent.	> Replace the needle.
Needle breaks	The needle is incorrectly inserted.	> Insert the needle with the flat side to the back as far up as it will go into the needle holder and tighten the screw.
	The fabric has been pulled.	> Feed the fabric evenly.
	Thick fabric has been pushed.	> Use the appropriate presser foot, e.g. Jeans foot No. 8 for thick material. > Use the height compensating tool when sewing over a thick seam.
	Knotted thread.	> Use quality thread.
Stitch width not adjustable	The selected needle and stitch plate cannot be used in combination.	> Replace the needle. > Replace the stitch plate.

Fault	Cause	Repair
Speed too low	Unfavorable room temperature.	> Place the machine in a warm room one hour before use.
	Settings in the Setup Program.	> Adjust the sewing speed in the Setup Program. > Adjust the slide.
The machine doesn't start	Unfavorable room temperature.	> Place the machine in a warm room one hour before use. > Connect the machine and switch it on.
	The machine is damaged.	> Contact the specialized BERNINA dealer.
Neither the sewing light nor the light on the free arm lights up	Settings in the Setup Program.	> Activate it in the Setup Program.
	The sewing light is defect.	> Contact the specialized BERNINA dealer.
Upper thread indicator doesn't react	Settings in the Setup Program.	> Activate it in the Setup Program.
	The upper thread indicator is defect.	> Contact the specialized BERNINA dealer.
Error during software update	USB stick is not recognized.	> Use a BERNINA USB stick.
	The update process is blocked and the hourglass on the display is inactive.	> Remove the USB stick. > Switch the machine off. > Switch the machine on. > Follow the instruction on the display.
	Date of the software update cannot be found.	> Unzip the update data. > Save data of the software update directly on the data medium and not in a file on the USB stick.

17.3 Error messages

Message on the display	Cause	Repair
	Stitch number unknown.	> Check the entry and enter the new number.
	Selection of the stitch pattern not possible in the combi mode.	> Combine other stitches.
	The feed dog is not lowered.	> Push the button «Feed dog up/down» to lower the feed dog.
	The selected needle and stitch plate cannot be used in combination.	> Replace the needle. > Replace the stitch plate.
	The needle is not at its top end.	> Adjust the needle position via the handwheel.
	The upper thread is used up.	> Rethread.
	The upper thread has broken.	> Rethread.
	The main motor isn't running.	> Turn the handwheel clockwise until the needle is at its top position. > Remove the stitch plate. > Remove the thread remnants. > Clean the hook. > Remove the hook and make sure that there are no pieces of broken needle points on the magnetic back of the hook.
	The contact between the machine and the embroidery module is interrupted caused by vibrations.	> Make sure that the module and the machine are standing on a stable, even surface. > Connect the embroidery module to the machine.

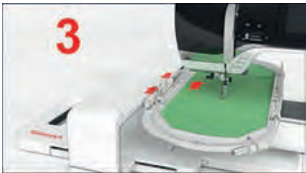
Message on the display	Cause	Repair
	<p>The needle position doesn't correspond with the center of the hoop.</p>	<ul style="list-style-type: none"> > Calibrate the hoop.
	<p>The embroidery module is not attached.</p>	<ul style="list-style-type: none"> > Connect the embroidery module to the machine. > Contact the specialized BERNINA dealer to have the machine checked.
	<p>The hoop is not attached.</p>	<ul style="list-style-type: none"> > Attach the hoop.
	<p>The hoop is attached.</p>	<ul style="list-style-type: none"> > Remove the hoop.
	<p>The movement of the hoop follows.</p>	<ul style="list-style-type: none"> > Touch the icon «Confirm».
	<p>Mega Hoop top.</p>	<ul style="list-style-type: none"> > Bring the Mega Hoop to the top position.
	<p>Mega Hoop center.</p>	<ul style="list-style-type: none"> > Bring the Mega Hoop to the center position.

Message on the display	Cause	Repair
	Mega Hoop bottom.	> Bring the Mega Hoop to the lower position.
	The embroidery motif is partly outside the hoop.	> Reposition the embroidery motif and start embroidering it again.
	The embroidery motif is too large.	> Reduce the size of the embroidery motif. > Attach a bigger hoop.
Too less free capacity on the BERNINA USB stick (optional accessory).	Not enough free capacity on the BERNINA USB stick (optional accessory).	> Make sure that the BERNINA USB stick (optional accessory) is used. > Delete data from the BERNINA USB stick (optional accessory).
No personal data on the BERNINA USB stick (optional accessory).	No personal data for recovery available on the BERNINA USB stick (optional accessory).	> Make sure that the data and settings have been saved on the BERNINA USB stick (optional accessory).
The recovery of personal data has failed.	The software update has been successful but the personal data couldn't be recovered.	> Make sure that the data and settings have been saved on the BERNINA USB stick (optional accessory). > Transfer saved data to the machine.
No BERNINA USB stick is inserted. Make sure that during the complete automatic update always the same BERNINA USB stick remains inserted.	The BERNINA USB stick (optional accessory) is not inserted.	> Use a BERNINA USB stick (optional accessory) providing enough free capacity.
The update of the software has failed.	The latest software version cannot be found on the USB stick.	> Make sure that the data for the software update has been unzipped. > Check whether the data for the software update are saved directly on the data medium and not in a file on the USB stick. > Update the software.

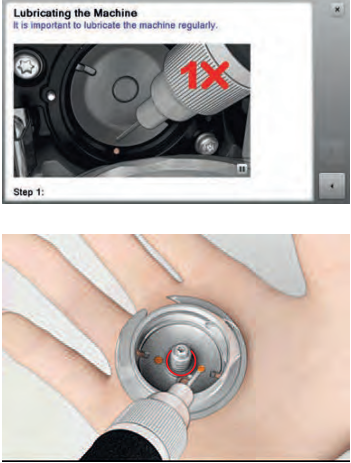
Message on the display	Cause	Repair
	<p>The machine needs cleaning/ lubricating.</p>	<ul style="list-style-type: none"> > Clean the machine. > Lubricate the hook. <p>Important information on lubricating: Too much oil can pollute the fabric and the thread.</p> <ul style="list-style-type: none"> > After lubricating, embroider a test piece first.
<p>It is time for the regular maintenance. Please contact your specialized BERNINA dealer to make an appointment.</p>	<p>The machine needs maintenance. The message appears after the programmed service interval has expired.</p> <p>Important information: Having your machine cleaned and serviced properly at the appropriate times ensures its proper functioning and a long service life. Failure to do so may adversely affect service life and limit the guarantee. The charge for servicing is nationally regulated – consult your dealer or servicing shop for more details.</p>	<ul style="list-style-type: none"> > Contact the specialized BERNINA dealer. > Delete the message temporarily by touching the icon «ESC». <p>Having cleared the message three times, the message will appear as recently as the next service interval has been completed.</p>

17.4 Storage and disposal

Storing the machine

It is recommended to store the machine in the original packaging. If the machine is stored in a cold room, place it in a warm room one hour before use.

- > Switch the machine off and disconnect it from the power supply system.
- > Don't store the machine outdoor.
- > Protect the machine against climatic influences.

Dispose of the machine

BERNINA International AG is committed to the protection of the environment. We strive to minimize the environmental impact of our products by continuously improving product design and our technology of manufacturing.

When the machine won't be used anymore, dispose this product in an environmentally responsible way according to the national directive. Do not throw away this product with your household waste. When in doubt, bring the machine to your local specialized BERNINA dealer.

- > Clean the machine.
- > Sort the components by their materials and dispose of them according to the local laws and regulations.

17.5 Technical data

Term	Value	Measurement unit
Maximum fabric thickness	10.5 (0,41)	mm (inch)
Sewing light	12 bis 16	LED
Maximum speed	1000	spm/rpm
Measurements without the spool pin	465/330/200 (18.30/12.99/7.87)	mm (inch)
Weight	11.5	kg
Energy consumption	90	Watt
Input voltage	100-240	Volt
Protection class (Electrical engineering)	II	
Production date: Can be seen on the type plate under «Code».		

18 Overview motifs

18.1 Overview Stitch patterns

Practical stitches

1	2	3	4	5	6	7	8	9	10	11
12	13	14	15	16	17	18	19	20	22	23
24	25	26	29	30	32	33	34			

Buttonholes

51	52	53	54	55	56	57	59	63	64	66
69	60	61	62							

Decorative stitches

Natural stitches

101	102	103	104	106	107	108	109	110	111	112
113	114	115	116	117	118	119	122	123	124	125
129	130	131	132	136	137	138	139	140	141	142

143	144	145	146	150	152	153	154	155	156	167
168	169	170								

Cross stitches

301	302	303	304	305	306	307	308	309	314	319
320	321	322	323	324	325	326	327	328	329	330
331	332	333	334	335	336	337	338	339		

Satin stitches

401	402	405	406	407	408	409	410	412	413	414
415	416	417	418	419	421	422	423	424	425	426
427	428	429	433	434	453	454	455	456	465	466

Ornamental stitches

601	602	603	604	605	606	607	608	609	610	611
612	613	614	615	616	618	619	620	621	622	623

624	625	626	627	628	629	630	631	633	634	635
637	639	640	641	642	643	644	645	646	647	648
649	650	651	652	653	654	655	656	657	658	660
661	662	663	665	666						

Heirloom stitches

701	702	703	704	705	706	707	708	709	710	711
712	713	714	715	716	717	721	722	723	724	725
726	727	729	730	731	732	737	739	741	742	743
744	745	748	749	750	751	752	770	771	772	773
774	775	776	777	778						

Novelty

901	902	903	904	905	906	907	908	909	910	911
912	913	914	915	916	917	918	919	920	921	922
924	926	928	935	938	939	940	944	945	946	948
950	954	961								

Quilt stitches

1301	1302	1303	1304	1305	1306	1307	1308	1309	1310	1311
1313	1314	1315	1316	1317	1318	1319	1320	1321	1322	1323
1324	1325	1326	1327	1329	1330	1331	1332	1333	1334	1335
1336	1337	1338	1339	1340	1341	1342	1343	1344	1345	1346













18.2 Overview Embroidery motifs

Editing embroidery motifs











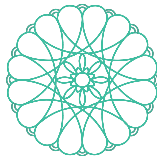

Let your inspiration run free. A vast selection of embroidery motifs is at your disposal.

If you see one of the following pictograms below a number of the embroidery motif, you can find additional information at

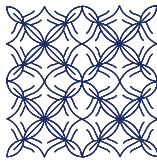
<http://www.bernina.com/5series>.





	Detached point		CrystalWork Design (sample)
	Hole embroidery		Cord embroidery
	Fringe embroidery		Projects in the hoop
	Appliqué		Puffy fonts
	CutWork Design (sample)		Quilting
	PaintWork Design (sample)		Trapunto

Quilt motifs



No.	Embroidery motif Colors	Width x Height > mm > inch	No.	Embroidery motif Colors	Width x Height > mm > inch
BD804	 	122 x 123 4.80 x 4.84	12499-06	 	101 x 101 3.98 x 3.98
12416-04	 	89 x 89 3.50 x 3.50	NZ498	 	88 x 88 3.47 x 3.47
12380-22	 	110 x 60 4.33 x 2.36	BD299	 	94 x 95 3.70 x 3.74





No.	Embroidery motif Colors	Width x Height > mm > inch	No.	Embroidery motif Colors	Width x Height > mm > inch
BD501	 ■	63 x 61 2.48 x 2.40			

Ornaments











No.	Embroidery motif Colors	Width x Height > mm > inch	No.	Embroidery motif Colors	Width x Height > mm > inch
NB251	 ■ ■ ■ ■	71 x 103 2.80 x 4.05	NB826-48	 ■ ■ ■ ■	134 x 132 5.28 x 5.20
80090-06 ■	 ■ ■ ■	83 x 37 3.27 x 1.46	21021-04	 ■ ■ ■	123 x 150 4.84 x 5.91

Flowers





No.	Embroidery motif Colors	Width x Height > mm > inch	No.	Embroidery motif Colors	Width x Height > mm > inch
21009-21	 ■ ■	64 x 107 2.52 x 4.21	21027-14	 ■ ■ ■ ■ ■ ■ ■ ■ ■ ■	120 x 120 4.72 x 4.72



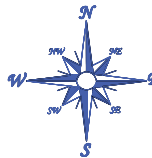

No.	Embroidery motif Colors	Width x Height > mm > inch	No.	Embroidery motif Colors	Width x Height > mm > inch
21002-02	 	109 x 160 4.30 x 6.30	FQ733	 	66 x 66 2.60 x 2.60

Children

No.	Embroidery motif Colors	Width x Height > mm > inch	No.	Embroidery motif Colors	Width x Height > mm > inch
BE790313 	 	98 x 102 3.86 x 4.02	CK867	 	122 x 132 4.80 x 5.20
BE790309 	 	87 x 149 3.43 x 5.87	BE790310 	 	137 x 136 5.39 x 5.35

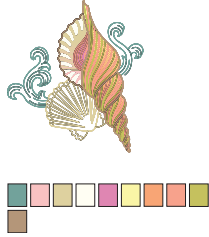

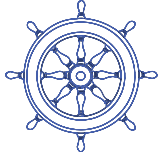
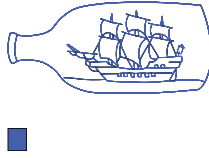

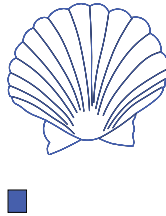

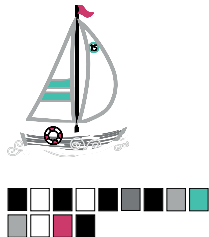
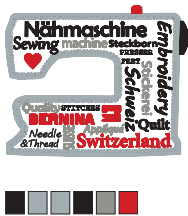

Seasons

No.	Embroidery motif Colors	Width x Height > mm > inch	No.	Embroidery motif Colors	Width x Height > mm > inch
NA614	 	101 x 101 3.98 x 3.98	21019_14	 	123 x 130 4.84 x 5.12









No.	Embroidery motif Colors	Width x Height > mm > inch	No.	Embroidery motif Colors	Width x Height > mm > inch
NB754-48		114 x 128 4.49 x 5.04	12421-37		67 x 61 2.64 x 2.40
12421-03		45 x 48 1.77 x 1.89	NA617		96 x 96 3.78 x 3.78
NA592		114 x 51 4.49 x 2.00	NC009-48		18 x 94 0.70 x 3.70
NA597		56 x 52 2.21 x 2.05			



Sports and hobby

No.	Embroidery motif Colors	Width x Height > mm > inch	No.	Embroidery motif Colors	Width x Height > mm > inch
80085-25		134 x 166 5.28 x 6.54	82014-28		141 x 117 5.55 x 4.61











No.	Embroidery motif Colors	Width x Height > mm > inch	No.	Embroidery motif Colors	Width x Height > mm > inch
12611-08 	 	80 x 119 3.15 x 4.69	12611-18 	 	130 x 157 5.12 x 6.18
12472-01	 	137 x 141 5.39 x 5.55			

Animals





No.	Embroidery motif Colors	Width x Height > mm > inch	No.	Embroidery motif Colors	Width x Height > mm > inch
WP415-48	 	132 x 148 5.20 x 5.83	CM213-48	 	58 x 102 2.28 x 4.02
CM216-48	 	47 x 67 1.85 x 2.64	NA248	 	77 x 73 3.03 x 2.87





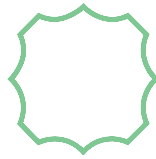

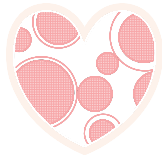
No.	Embroidery motif Colors	Width x Height > mm > inch	No.	Embroidery motif Colors	Width x Height > mm > inch
CM220 	 	71 x 71 2.80 x 2.80			

Borders and Lace









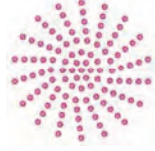

No.	Embroidery motif Colors	Width x Height > mm > inch	No.	Embroidery motif Colors	Width x Height > mm > inch
21021-25 	 	33 x 71 1.30 x 2.80	12659-06 	 	36 x 59 1.42 x 2.32
21002-21	 	21 x 151 0.83 x 5.95	FB436	 	29 x 132 1.20 x 5.20

Frames and borders

No.	Embroidery motif Colors	Width x Height > mm > inch	No.	Embroidery motif Colors	Width x Height > mm > inch
12611-27 	 	136 x 137 5.35 x 5.39	12649-05 	 	91 x 88 3.58 x 3.47

No.	Embroidery motif Colors	Width x Height > mm > inch	No.	Embroidery motif Colors	Width x Height > mm > inch
32078-04 	 	123 x 173 4.84 x 6.81	NZ195 	 	76 x 76 2.99 x 2.99

Designs with special effects

No.	Embroidery motif Colors	Width x Height > mm > inch	No.	Embroidery motif Colors	Width x Height > mm > inch
DW11 		70 x 71 2.76 x 2.80	12448-09_ PW 	 	121 x 161 4.80 x 6.30
21022-13_ DW  	 	105 x 192 4.13 x 7.56	DW05 		105 x 94 4.13 x 3.70

A

Activating the audio signals	62
Activating the upper thread indicator	62
Adjusting the brightness of the display	63
Adjusting the maximum sewing speed	54
Adjusting the presser position via the knee lifter of the Free Hand System	41
Adjusting the sewing light	64
Adjusting the upper thread tension	54
Alphabets	108
Altering the stitch density	152
Attaching the BSR presser foot	125
Attaching the FHS knee lifter	35
Attaching the hoop	143
Attaching the Module	135
Attaching the stitch plate	139

B

Back to default setting	66
Buttonholes	110

C

Calibrating the Buttonhole foot with slide No. 3A	68
Calibrating the hoop	58
Calling up the Creative Consultant	72
Calling up the Help	72
Calling up the Tutorial	72
Changing the needle	43
Changing the presser foot	41
Changing the stitch plate	45
Checking the firmware version	64
Child safety feature	72
Cleaning the feed dog	167
Cleaning the hook	167
Cleaning the thread catcher	70
Combi mode	78
Combi-Mode	153
Combining embroidery motifs	153
Connecting the foot control	35
Cord	113

D

Decorative stitches	103
Dispose of the machine	177

E

Embroidery file format	132
Embroidery test	133
Error messages	176

I

Included accessories	23
Inserting the embroidery needle	138
Introduction	18

K

Key to signs	19
--------------	----

L

Lubricating the hook	168
Lubricating the machine	70

M

Maintenance and Cleaning	167
Moving the hoop to the back	144

N

Needle stop up/down (permanent)	44
Needle, Thread, Fabric	30
Needle/thread combination	33

O

Overview embroidery module	129
Overview Embroidery motifs	183
Overview Stitch patterns	179

P

Pintucks	105
Placing the thread disc	38
Positioning the embroidery hoop virtually	145
Power save mode	72
Practical stitches	87
Programming the securing stitches	54

Q

Quilting	122
----------	-----

R	
Raising/Lowering the needle	37
Registering details of the dealer	65
Regulating the speed	74, 147

S	
Safety instructions	14
Saving Service data	66
Selecting a language	63
Selecting a stitch pattern	74
Selecting embroidery motifs	136
Selecting personal settings	61
Sewing a test sample	115
Sewing with connected embroidery module	144
Storing the machine	177
Supplied accessories	129

T	
Technical data	178
Threading the bobbin thread	50
Threading the double needle	48
Threading the triple needle	49
Threading the upper thread	46
Troubleshooting	172

U	
Updating machine firmware	68
Upper thread tension	56, 165
Using a spool net	39
Using eco mode	72

W	
Welcome to the world of BERNINA	18

